



HST

SYSTEMTECHNIK

IT & Automation II



From a single source

HST always thinks one step ahead. So it is hardly surprising that we have become a systems supplier of key technologies for the water and energy industries. After all, we are convinced that networking will be a central issue in the future. There is huge potential for innovation here, where processes can be made more effective and resources protected more efficiently. HST has always thought in terms of systems, right from the word go! We have proven this in the over 10,000 successful projects we have carried out. HST's IT products are unique since HST not only develops software, but also designs ma-

chines and equipment with integrated software. This is what gives us the competitive edge and gives our customers added value. We know how the processes function and can therefore design the ideal software.

And we don't stop there: We are playing a key role as an initiator and coordinator in the trend-setting research project „MUNICIPAL 4.0“ which enables us to be proactive in the water management market. We have used our intelligent software to transform electro-mechanical machines such as the AWS-Jet Cleaner and

Contents

Networking	4
KANiO® operations management software	15
KANiO® ISMS tool IT security	43
SCADA V10 SCADA-Systems	49
SCADA.web process data portal	79
TeleMatic control & monitoring	91
NiRA.web® precipitation portal	105
SensoMatic data capture	111
IntelliSysteme machine & process control	117
HST academy.....	125
About HST.....	131

our horizontal bar screens into intelligent, smart machines. This enables processes to be optimised and use a more cost and energy efficient mode of operation. Using historical, current and forecast precipitation data from the NiRA.web® data portal, the smart machines with intelligent software operate in a more predictive manner. They can also be connected using the Intelli.Net system in order to achieve data- and fail-safe network management, both today and in the future.

Dipl.-Ing. Martin Frigger
Managing Director

Dipl.-Ing. MBA Werner Bucker
Managing Director

Dipl.-Ing. Richard Ernst
Managing Director

Dipl.-Ing. Thomas Gröb
Managing Director

next level technology

Let's take a look into the future: As resources in the water and energy industries become increasingly scarce, intelligently networked systems which take advantage of synergies to boost efficiency are in greater demand than ever before. Ideally, these systems should generate information as the basis for reliable forecasting. Over the past years, HST has launched a whole range of forward-looking software products in the field of IT & automation which guarantee complex process control and optimum added value. For example, using its web-based data service NiRA.web®, HST can record and forecast precipitation over a wide area. Operators of flood protection installations as well as users from the agricultural sector

both value this service as it enables them to deploy their resources more efficiently.

And it doesn't stop there: In terms of the capture, transfer and evaluation of process and machine data, HST and its web-based solutions in the field of SCADA and operations management are leading the way. We have achieved efficiency in data capture with the Delta Event method whereby, in line with the principles of DATA EFFICIENCY, the customer only receives the information required for the situation at hand. Moreover, all our solutions are based on a clear, user-friendly and intuitive design.

Great news from the future - the flood of data can be managed

A man in a dark suit and tie is standing in a control room, pointing at a large digital display. The display shows a complex interface with multiple data curves and graphs. The background is a modern office environment with desks and chairs. The entire scene is overlaid with a blue tint.

October 2021, a major city in Germany: Martin Tröger views two curves in the municipal waste water control centre. Today just two curves are out of the ordinary. Everything else is looking great. Mr Tröger knows all this thanks to his HST SCADA system which performs independent analyses and which is fed information by numerous little helpers: Strategic measurement points in the sewage network which supply your data to the HST SCADA system. In the past, Mr Tröger had to view all the data curves for the 70 plants, including rainwater basins and pumping stations, on a daily basis and to inspect these for unusual results. Despite his extensive experience, he still required two hours to view the approx. 500 curves. Then in 2013 the number of measurement parameters grew further. Big data! Increasing numbers of qualitative measurements, e.g., on waste water quality, were included, the environmental regulations become more complex, EU regulations stipulated an expansion of the measurements required. Mr Tröger's colleagues from the water plant, where the entire data volume comprises more than 15,000 data points, have also opted for HST SCADA. Huge time savings and reduction in workload HST SCADA: The machete for the data jungle.

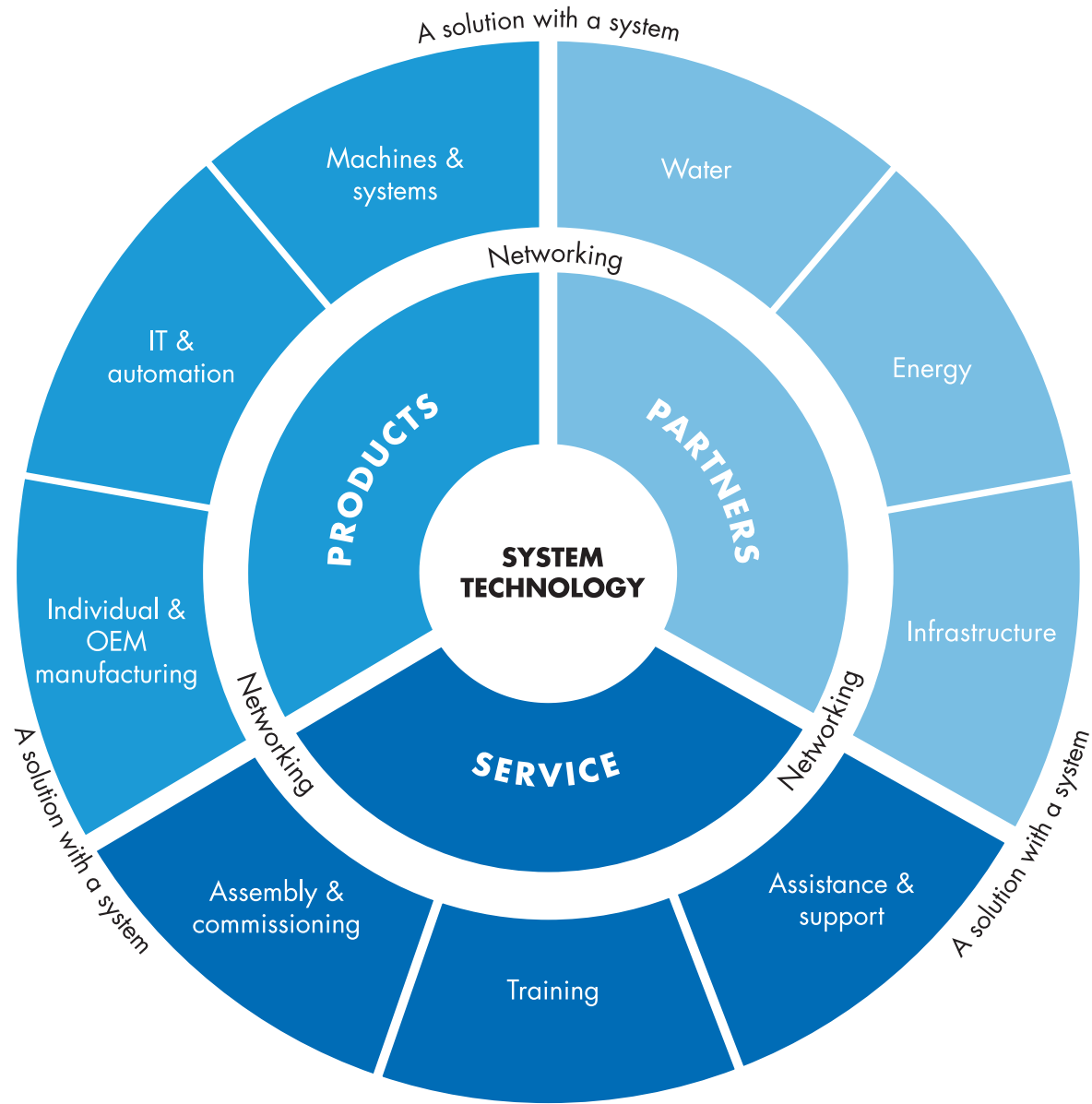

Networking that works perfectly

„Intelligent“ systems require that everything is optimally interlinked. It is also necessary to be able to identify connections and „think outside of the box“. Moreover, you should be familiar with every single detail of the system and, ideally, you should have developed it yourself. HST therefore not only offers networking (IT & Automation) but also the components to be networked (Machinery & Equipment) together with their maintenance and servicing (Services). Over the past 35 years and based on the experience garnered from more than 10,000 projects, one thing is clear: IT has made a system that is “more” than the sum of its parts.

Personal responsibility

The answer lies in the system and networking. System technology, which we bring to perfection, is at the heart of our service circle. Depending on our customers' requirements, we design tailored products, projects and services from a single source. This extends from resource-saving heat exchangers and smart process control technology through to equipping of a complete flood water project. However, our services don't end with the sale of a product or the final approval of a project. We feel personally responsible and aim to further our customers' success in the long term. That's why, operation, inspections, maintenance and servicing are an integral part of our range of services.

Achieving the exceptional

Admittedly we can't do everything. But we do excel in our market. We are second to none. Put our technicians and engineers to the test.

HST service expertise

It's all networked: We have positioned our projects, products and services around our core expertise in “system technology”. As such, we can satisfy all the demands made by our customers. In our view, this is the key to our success.

The right fit for everyone

Every project is different. It is therefore extremely important to be able to flexibly adapt to new framework conditions. We have proven this until now with over 10,000 successful projects and numerous products. Our customers include:

- Communities, associations, operators
- Engineering offices and planners
- Public utilities companies
- Industry and trade
- System manufacturers, original equipment manufacturers



Communities, associations, operators

Safety is our top priority when it comes to planning and financing as well as the construction and maintenance of your municipal infrastructure. We know that especially in water management, but also in regenerative energy industry, large renovation and new construction projects are planned in the coming years in many places. We will take on this huge responsibility together with you. Benefit from our know-how and our outstanding products, e.g., SCADA.web, the innovative online equipment monitoring system.

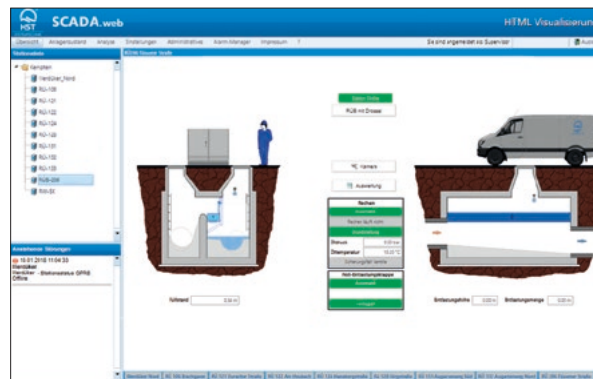

SCADA.web can be found on page 76

Engineering offices and planners

What is important to you as a planner when you conceptualise systems and installations for the water management, energy industry and other infrastructure industries? Certainly that they are efficiently designed and assessed. HST supports you exactly with this – thanks to creative solutions such as, for example, the modern and open TeleMatic remote control system. Be it with market-leading products, projection recommendations, circumspect planning, for example when calculating the cost effectiveness, the creation of drawings and announcement texts or a comparison for investment and operating costs and, finally, of course with implementing the project.

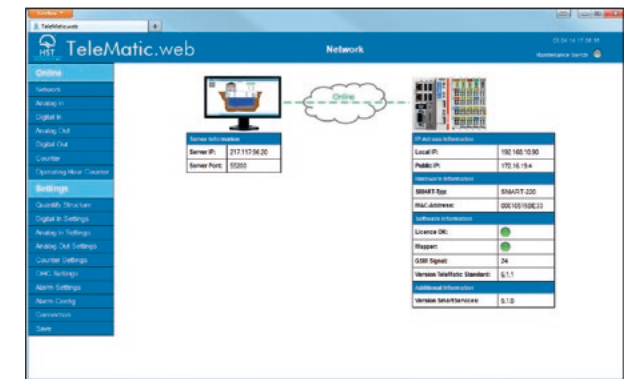

TeleMatic can be found on page 91

Public utilities companies

Even today public utilities companies bear a lot of responsibility for the safe, economic and environmentally friendly operation of their own infrastructure. Enormous efficiency potential can be realised here with the networked IT solutions from HST. The more intelligent the networking, the better the result. HST is at hand to help. Whether for new constructions, renovations or for operation: We supply everything from a single source. For the servicing, planning and control of technical processes, for public utilities companies the focus is on the KANiO® operations management and maintenance software. This enables working processes to be tangibly simplified and data to be reliably documented on site.

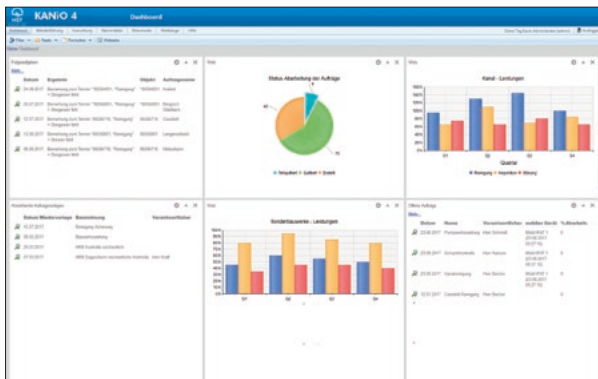

You will find KANiO® mobile on page 15

Industry and trade

Be it for technical operations management or for process and waste water management: Together with you we identify the cost drivers in your company and develop solution strategies. Have you ever considered making good use of your waste water heat? Let us discuss the potential of your company in terms of equipment and technology in the water management, energy management and other infrastructure areas. You will be amazed at what is possible. Have you ever considered the impact of precipitation on your processes? NiRA.web® provides all the information required simply and flexibly.

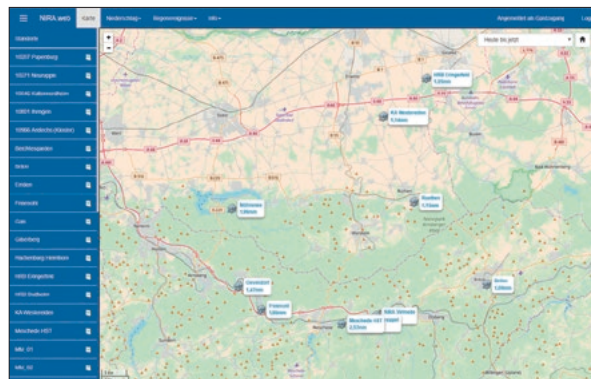

NiRA.web® can be found on page 105

System manufacturers, original equipment manufacturers

When equipping your products, remember that the future lies in networking products. The software in your products should therefore be adapted accordingly. Of course, the decision in favour of this kind of software must be well considered. However, we have already been able to demonstrate our leading edge in numerous applications. We would be delighted to demonstrate to you our customised IT and automation solutions, including under the framework conditions stipulated by you. You can use our software products in your solutions or, alternatively, use our developments for independent products marketed under your brand name.

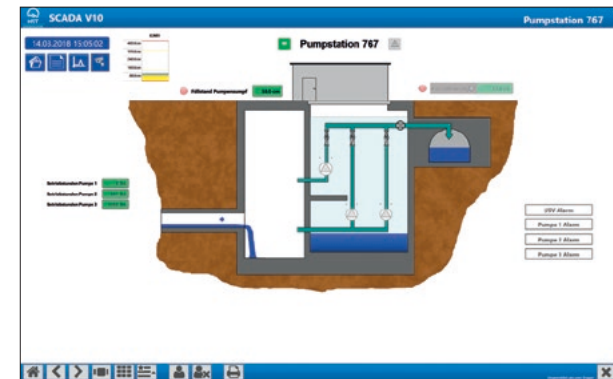

SCADA V10 can be found on site 58

IT from HST: Seamlessly compatible on all levels

Whether measurement technology, automation, process control technology or operations management: HST always develops integrated IT systems. For us, information technology starts with data capture. As such, relevant information can be used transparently on all levels. Our HST TeleMatic remote control system can be linked seamlessly with our SCADA systems SCADA V10 and SCADA.web. These advantages are available online with SCADA.web, the portal for cost-saving equipment monitoring, and the NiRA.web® portal.

Open and flexible

Our IT systems are characterised by open and established standards. Interfaces to leading GIS systems are as self-evident as the connection to ERP systems (including SAP) and automation systems. The modern web products from HST are platform-independent and only require an Internet browser.

Stay ahead of the game

Our development engineers work to ensure that our products are developed continuously. New user requirements are pooled and realised. And, at the same time, we ensure that our system compatibility is not compromised. As such, productive data from equipment which were commissioned at the start of the 1990s can be used in current product versions despite numerous technological changes.

Freely scalable and available

Products from HST can be adapted to the size of the machine, equipment or organisation. The range of IT systems extends from a simple single workstation and network systems through to redundant hot standby and cluster systems in native and virtual system environments.

Smart solutions for dynamic processes

System technology as we understand it at HST brings together products, software and project handling with such perfection that economic efficiency and diversity can be achieved together with maximum security and availability. This is possible due to the smart interlinking of equipment and machinery which enables complex processes to be managed and repeated with great reliability. This results in processes developed with an optimum technical and economic design.

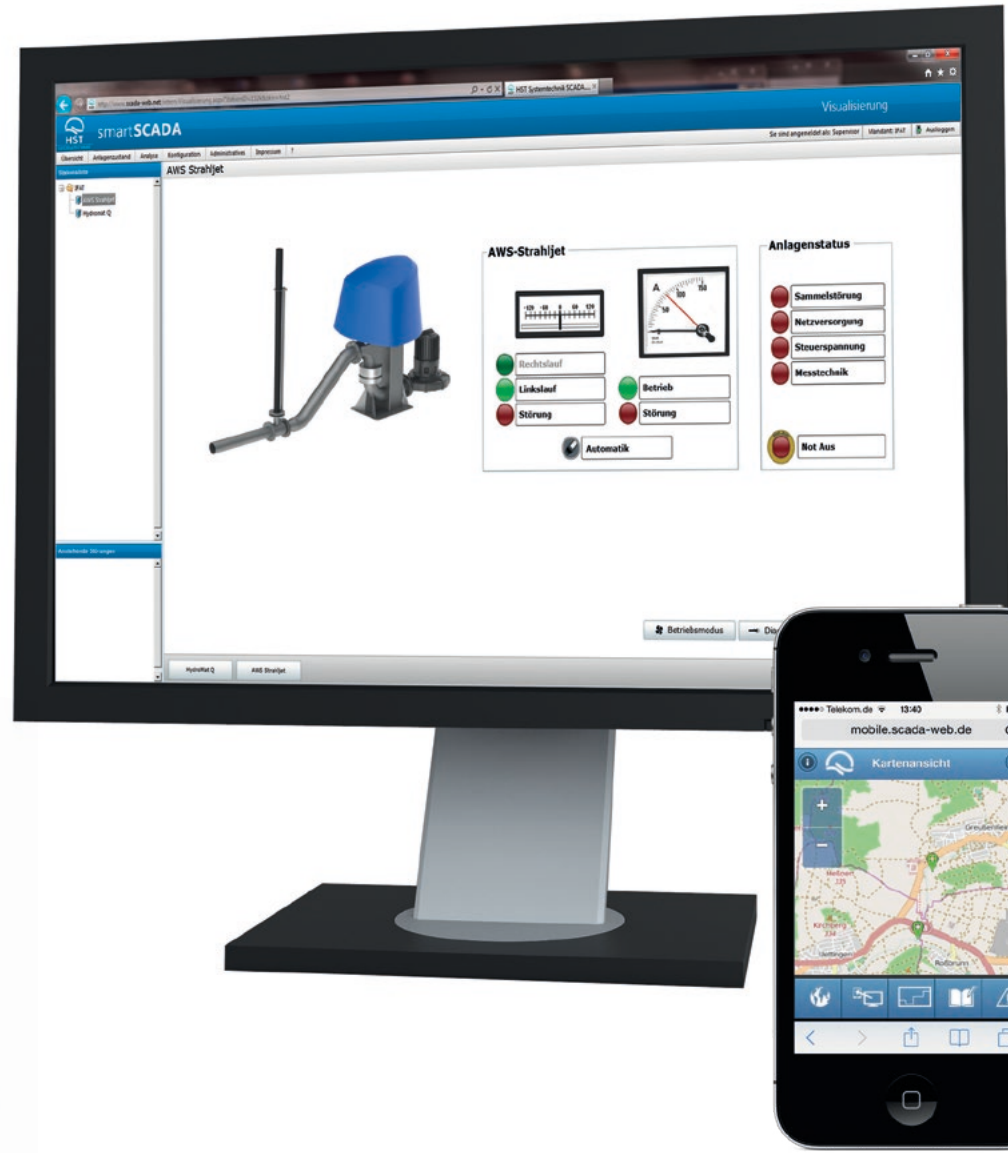

OPERATION MANAGEMENT



KANiO® ISMS IT security management-system



KANiO® Operations management software portal solution



smartKANiO maintenance software for machines

TCP/IP, Internet ...

PROCESS CONTROL



SCADA V10 SCADA-Systems Client server solution



SCADA.web Process data portal solution



smartSCADA Software to control machines

... Windows, OPC, OPC-UA, IEC 6070, IEC 61131, IEC 61850 ...

AUTOMATION MONITORING OPERATION



IntelliSysteme machine and process control by data/sensors (IoT key components)



HydroMatic SPS-software modul for machine control



TeleMatic control and monitoring

... EtherCAT, PROFINET, PROFIBUS, Modbus

SMART MACHINES
Machines with special automation intelligence as smartSCADA and smartKANiO



AWS-Jet Cleaner with IntelliGrid



ASA-Weir with IntelliFlow



HSR-Screen with IntelliScreen

... Ethernet, WLAN, GPRS, UMTS, LTE

DATA/SENSORS



Sensomatic-EMA data capture



TeleCam Visual process control



NiRA.web® Precipitation portal

Clever networking on all levels

HST products are intelligently networked across all process levels based on established standard technologies. In addition to classic communication paths, e.g., of a physical network infrastructure, new approaches such as the connection of IoT process data are supported. This opens up completely new opportunities such as the connection of process data from the cloud.

Operations management

Operations are organised on the operations management level. Maintenance, planning and control are the central tasks in this area. KANiO® has been developed with exactly this in mind and also offers interfaces to established ERP and GIS systems.

Process control technology

At the process control level, the focus is on operating and monitoring processes. At the interface between the operator and process (HMI Human Machine Interface), the SCADA systems from HST really come into their own: Interactive operation and efficient data recording following a Delta event.

Automation, monitoring, operation

The TeleMatic system is the innovative solution for automation technology. The use of PC-based automation platforms offers major advantages, especially in connection with modern Internet-based communication technologies such as GPRS, LTE and DSL.

SMART machines

SMART machines are a system solution comprising hardware and software. Additional sensors and actuators are linked with the SMART machine software and enable efficient equipment operation using software which is specially tailored to the machine. SMART machines are supplied with additional information, e.g., the latest precipitation forecasts, via IoT process variables..

Data/sensors

In terms of data/sensors, HST not only focuses on classic sensor and actuator technology and the various field bus systems for networking, but also focuses on the topical issues of visual sensors (HST TeleCam), NiRA.web® intelligent rain meters which are available everywhere and, of course, the set of issues surrounding condition monitoring.



KANiO®

Operations management software
Overview, organisation and order in operations

KANiO® – Overview, organisation and order in operations

The four pillars of the HST solution offering

Anyone with more than 20 years of experience in technical operations management has a solid foundation and intimate know-how of the users' needs. As such, we can arrive at a system that can handle even the most complex of requirements. At HST we don't want to talk you into purchasing KANiO®. We want you to see the benefits for yourself. That is why we can promise you four things from the outset:

Rapid success

What you can rely on: The transfer from your current approach to KANiO® is extremely quick and operation is intuitive. After that, you have all the important data for productive operation and can achieve, on average, an increase in efficiency of around 30 percent in the first year.

Integrative system

KANiO® is a system which adapts flexibly to your needs in many respects. Needless to say it integrates existing IT structures such as your GIS, your process control technology and your commercial system. This enables optimal networking of all important elements.

Support during process change

KANiO® results in maximum transparency for your operations. Accordingly, it is ideal for identifying optimisation potential in your processes. You can rely on HST's many years of experience when implementing KANiO® and our qualified staff are on hand to offer expert support.

Assured process reliability

Implementation of KANiO® reduces your risk of investment. After all, HST offers a guarantee on your investments which, in turn, ensures process reliability. This means HST assures that your processes in the new operations management system run reliably. All of this is only possible because KANiO® functions so optimally.

Efficiency gains without compromising quality: Operations management must be safe and reliable

Technical operations become more efficient and economic with KANiO®. This applies both to preparation and planning as well as documentation. It goes without saying that KANiO® is able to handle all servicing planning and quality assurance and also ensure compliance with the statutory regulations.

Various industrial applications enable use in different organisational units, e.g., canal operations, sewage treatment plants, gas supply, water supply and power supply companies and well as for industry. KANiO® can be deployed in a wide range of sectors and always ensures maximum flexibility and compatibility. It is therefore ideally equipped to take on future challenges.

An apt example: Public utilities companies. The challenges are increasing all the time here; there is a growing need to ensure the reliability of supply of operational procedures. The technical operations manager is at the heart of a continuous and foreseeable change process which will have a major impact

on public utilities companies in Germany over the coming years. For example, the newly announced attempt on the part of the Federal Network Agency to integrate process costs to a greater extent will come into effect soon. The aim of this is to allow the market supply to be compared and, ultimately, to achieve optimal energy efficiency.

The growing requirements of the Federal Network Agency

Public utilities companies which fail to take precautions in good time will be hit hard by the pending requirements. The stipulated degree of transparency for processes and structures cannot be achieved overnight. Many years of preparation and an extensive changeover is required. In addition, given the new level of comparability, the management of public utilities companies will endeavour to make costs as optimal as possible. And, on top of all this, the supply mandate for public utilities companies is set to change continuously in response to the changes in catchment areas.

Meeting in-plant demands

A new system for operations management, which is able to meet these demands, has to satisfy numerous parties. For the GIS department, which has data sovereignty, it must be ensured that the data is transferred safely and fully from the GIS to operations management. Alongside the requirements set out by commercial management, the technical operations department expects the safe and flexible handling of all technical processes with the system. The system must be able to flexibly shape the planning of working processes, the organisation of resources and the management of daily operation. Introducing a new system in this environment can be compared with open heart surgery. This makes it all the more important to enable a rapid and reliable changeover from the old approach to the new system. HST understands this.

Application areas

GAS – Safe and efficient

Reliable and continuously controlled gas operations are essential given its exposed position in terms of energy supply in Germany. The „Gas“ industrial application allows you to plan, document and service gas supply equipment. Record all equipment data digitally and create the prerequisites for condition-based maintenance. Further information, e.g., plant images, manufacturer instructions, cross-section drawings and spare parts lists can be assigned to the systems or individual components in KANiO®.



WATER - Hygienically clean

Drinking water has to satisfy the most stringent of demands and specifications. This makes perfectly aligned processes within the water plant even more important. Alongside recovery, treatment and storage, the distribution of drinking water is also a focal point. Reliable framework conditions have to be in place for all these processes. KANiO® makes monitoring, needs-based servicing and process optimisation possible. What's more, with KANiO® processes and results can be ideally documented and the statutory regulations can be managed accordingly.



POWER – Without any compromises

Power is the driving force behind progress and wealth. With the „Power“ industrial application, KANiO® guarantees legal documentation, planning, maintenance and administration of your networks and equipment which you use for the public power supply. Within the scope of cost reduction, KANiO® functions as a smart control unit for monitoring maintenance intervals etc. Which means only that which needs maintenance is actually maintained. At the end of the day, KANiO® pays off in a whole host of ways.



SEWAGE NETWORK - Foresighted operation

Canals used to transport domestic and commercial waste water are subject to continuous testing and monitoring in order to sustainably protect the costly investments which have been made into constructing and renovating sewage networks over the past years. KANiO® acts as an ideal planning tool to support the numerous tasks to be performed in the sewage network based on instruction sheet DWA-M 175-1 or the individual inspection ordinances of the federal states.



SEWAGE TREATMENT PLANTS – Structured visualisation

Sewage treatment plants, whether large or small, comprise a considerable range of fixtures and installations. In order to visualise the plant installations together with all the key figures, KANiO® offers the „Sewage treatment plant“ industrial application. All maintenance measures within the scope of servicing are planned based on the object information and activities using the standard KANiO® range of functions. The captured data combined with the equipment documentation is merged in KANiO® where it is available for evaluation and visualisation of the necessary key data.



INDUSTRY – Cost-efficient & standardised

Motivated by the desire to avoid plant downtimes and the associated costs, industrial operations often consider introducing standardised maintenance software. KANiO® is ideally tailored to the needs of technical operations and functions as an ideal tool. Interfaces to customary ERP systems for integration into the existing system environment are available as standard. The internal processes are thereby optimised and added value is enhanced. Maintenance costs are minimised and, by exploiting the optimisation potential offered by the processes, maximum machine and equipment availability is guaranteed..





KANiO[®] – modular and flexible

KANiO[®] modular system

KANiO[®] was deliberately designed to be modular and open. As such, users can configure and scale their KANiO[®] specifications according to the size of their operations. The ideal depth of configuration can be achieved for every conceivable application. The module areas represent functional classification criteria in the system. One or more modules are allocated to each module area. The modules are the functional building blocks in the system and can be licensed individually.

Dashboard

The dashboard is the first thing you see when you call up KANiO[®]. Here the key information tailored to the user is shown without having to search in the various program modules. This can be, for example, recurring measures, operational messages from the control system, excerpts from evaluations or non-scheduled damage reports. Starting from the dashboard, users can go directly from the information shown to the respective KANiO[®] program module for further processing. The dashboard enables the information to be tailored for the relevant user.

Operations management

Within operations management in KANiO[®], you will find all the key modules/functions to organise your day-to-day procedures. The user is quickly provided with an overview of all the relevant pending measures, regular tours and scheduling.

Master data

The basic data is structured in the system within the „Master data“ module area. This includes the integration and structuring of equipment, activities, resources and storage articles. The master data is stored and maintained at this central point in the system. The objects are copied from the supply network to the „Equipment“ module via existing interfaces, e.g., to the GIS.

Evaluation

In the “Evaluation” area, the operation of individual parts of the plant or entire sections of the network can be displayed with the aid of simple queries or graphical reports. The pertinent information for these is supplied in the selected form by prepackaged filter queries or report templates. The templates can be customised or created by the operator himself. This enables optimal flexibility independently of the manufacturer.

Documents

In the “Documents” area, the user can access the KANiO[®] document management module. Documents can be filed directly for the individual plant parts or generally at the higher level for operation. The documents can be opened directly via a link, and also changed if the user has the necessary authorisations. KANiO[®] enables the integration of individual documents or entire document structures.

Tools

In the “Tools” module area, the user has the option to make individual default settings in the system. For example, the data fields or tree configurations can be adapted here. This is also where filters or the contents of catalogues can be defined.

The screenshot displays the KANiO 4 software interface, which is used for managing water supply infrastructure. The main window is titled 'Betriebsmittel' and features a navigation menu with options like 'Dashboard', 'Betriebsführung', 'Auswertung', 'Stammdaten', 'Dokumente', and 'Werkzeug'. The left sidebar shows a hierarchical tree structure under 'Betriebsmittel', including 'HRB's (9)', '*Kanalnetz (1027)', '*Ackerweg (4)', and 'Haltung (26)'. The 'Haltung' folder is expanded, showing a list of individual holdings with their IDs, such as *66584691, 66584692, 66584693, etc.

The right pane shows the configuration form for the selected holding, 'Haltung - *66584691'. The form is divided into several sections:

- Name:** *66584691
- AKZ / Kurzname:** (empty field)
- Sammlername:** PW Feldtorstraße
- Entwässerungszweig:** Sammler Solinger Straße
- Nr. des Sammlers/Gewässers:** 13
- Nr. der Einleitungsstelle:** 1.301
- Straße:** Ackerweg
- Baujahr:** 1959
- Entwässerungssystem:** Schmutzwasser
- Wasserschutzzone:** Klasse IIIa
- Eigentum:** städtischer Kanal
- Kreuzung mit DB-Anlagen
- Haltungsfunktion:** (empty field)
- Unterhaltungspflichtig:** Nein
- Anzahl Einläufe:** (empty field)
- Grundwasserstand:** unbekannt
- Straßenschlüssel:** 1378
- Anzahl Anschlüsse:** 0
- Kostenstelle:** U2121000
- Betriebsbehörden:** Reparaturen nach Besichtigung
- Baustatus:** (empty dropdown)
- Druckstufe:** 1
- Baummaßnahme:** K4 / 29-2

At the bottom of the interface, there is a pagination control showing 'Gehe zu Seite 1 von 21' and a URL: '/intern/Forms/LEITUNG_0.aspx?datatypeid=1006&compStorage=N&id=54566'.

KANiO® Equipment management

DESCRIPTION

All network objects and systems at a glance: Equipment management maps all the technical systems and facilities that must be managed in one streamlined tree structure. All the master data for network objects and systems that is relevant for planning is also displayed here. The proprietary KANiO® graphics viewer is available either in a stationary or mobile version and provides real support for planning and execution, particularly during network operation. The graphics provide employees with additional guidance..

YOUR BENEFITS

- Clear structure
- Transparency
- Direct access to all information relating to the object

APPLICATIONS

With this module, all technical facilities can be structured and mapped clearly. The grouping can be carried out here according to an enormous range of criteria, e.g., districts, streets or buildings. The structure can have any number of levels.

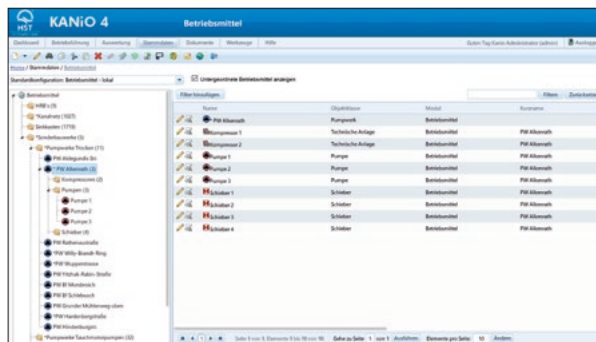

Equipment management

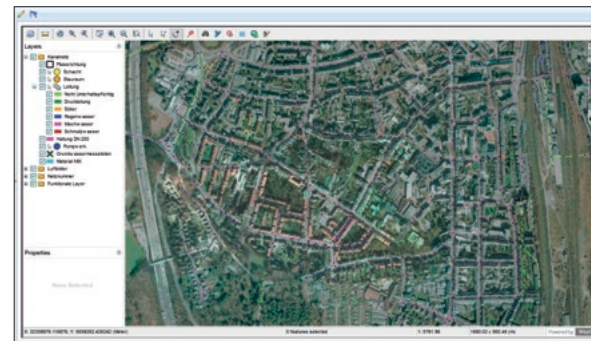

Graphics connection

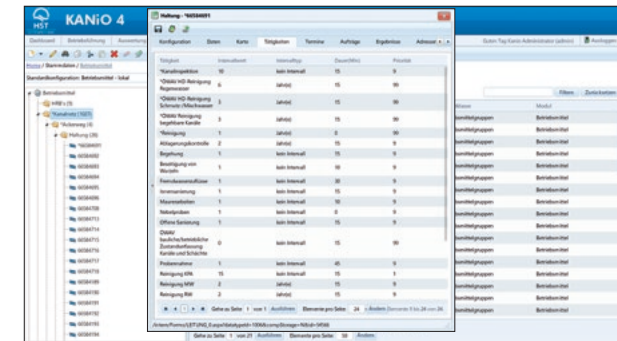

Activity assignment

The screenshot displays the KANiO 4 web application interface. The top navigation bar includes 'Dashboard', 'Betriebsführung', 'Auswertung', 'Stammdaten', 'Dokumente', 'Werkzeuge', and 'Hilfe'. The user is logged in as 'Guten Tag Kanio Administrator (admin)'. The main content area is titled 'Tätigkeiten' and shows a tree view on the left and a table on the right.

Tree View (Left):

- Tätigkeiten
 - HRB (7)
 - Kanalnetz (14)
 - *Haltung (11)
 - *Reinigung
 - Ablagerungskontrolle
 - *Kanalinspektion
 - sonstiges KU32
 - Zustandserfassung Haltung
 - Probennahme
 - Fremdwasserzuflüsse
 - Nebelproben
 - Sonderuntersuchungen
 - Zustandsweiterfassung Haltung
 - Begehung
 - Abscheideeinrichtung (4)
 - Druckentwässerungsnetze (8)
 - Sonderschächte (11)
 - Sonstige Aufgaben (10)
 - Speicherbauwerk (5)
 - Übergabepunkt (2)
 - Druckleitung (5)
 - Düker (5)
 - Einleitungsbauwerk (4)

Table (Right):

Name	Objektklasse	Kurzname	Modul
*Reinigung	Tätigkeit		Tätigkeiten
*Ablagerungskontrolle	Tätigkeit	Ablagerungskontrolle	Tätigkeiten
*Kanalinspektion	Tätigkeit	Zustandserfassung	Tätigkeiten
*sonstiges KU32	Tätigkeit	sonstiges KU32	Tätigkeiten
*Zustandserfassung Haltung	Tätigkeit	Zustandserfassung	Tätigkeiten
*Probennahme	Tätigkeit		Tätigkeiten
*Fremdwasserzuflüsse	Tätigkeit		Tätigkeiten
*Nebelproben	Tätigkeit		Tätigkeiten
*Sonderuntersuchungen	Tätigkeit		Tätigkeiten
*Zustandsweiterfassung Haltung	Tätigkeit	Zustandserfassung	Tätigkeiten
*Begehung	Tätigkeit		Tätigkeiten

At the bottom of the interface, there is a pagination control showing 'Seite 1 von 1, Elemente 1 bis 11 von 11. Gehe zu Seite 1 von 1 Ausführen Elemente pro Seite: 11 Ändern'.

KANiO® Business management

PRODUCT DESCRIPTION

By using KANiO® technical operations can be run more efficiently and more economically. This applies not only to preparation- and planning process but also to documentation. It is a matter of course that with the aid of KANiO® (version KANiO® 4.0) the complete maintenance planning and quality assurance as well as the compliance with legal requirements can be achieved. Standard application modules allow the usage in a large variety of organisations such as, for example, river and channel management, treatment plants, gas, water and electricity operations.

YOUR ADVANTAGES

- Market leading operation system in the water industry
- Further applications in gas and electricity plants and in general industry
- Integration into GIS, PLS and ERP systems
- Standard application modules with special functions such as wash down operations in channel management.
- Mobile applications

USE

- Operation and maintenance of water, transport and lighting networks as well as general infrastructure
- Maintenance organisation and industrial operations
- Real estate, building and plant maintenance

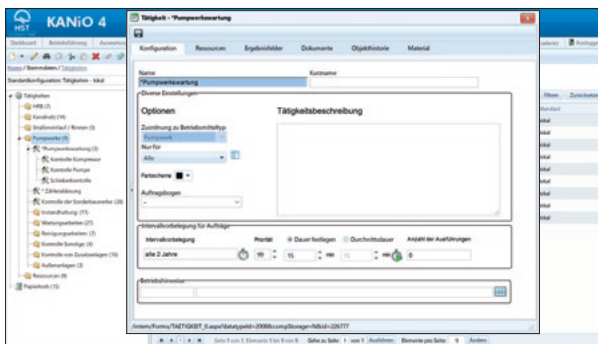

Business management

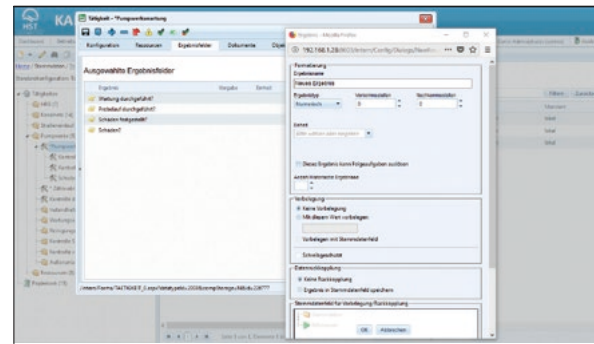

Result creation

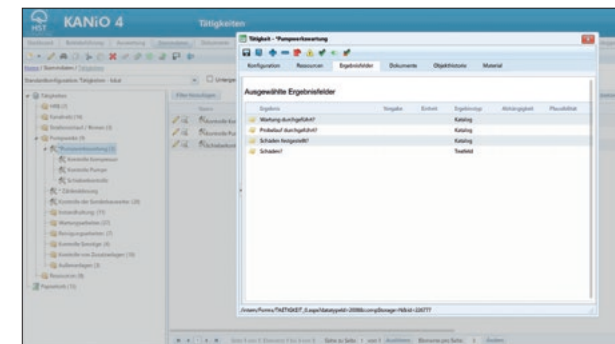

result assignment

The screenshot displays the KANiO 4 software interface, which is used for resource management. The main window is titled 'Ressourcen' and features a navigation menu with options like 'Dashboard', 'Betriebsführung', 'Auswertung', 'Stammdaten', and 'Dokumente'. The left sidebar shows a hierarchical tree of resources, including 'Fahrzeuge' (8 items), 'Sachmittel' (5 items), and 'Personal' (5 items). The 'Personal' category is expanded, showing 'Team 1 (2)', 'Team 2 (2)', and 'Team 3 (3)'. The 'Person - Mitarbeiter 6' window is open, showing the 'Ressourcentyp' (Resource Type) configuration. The 'Eigenschaften' (Properties) section is checked for 'Führerschein Klasse B', 'Schlosser', and 'Schweißschein'. The bottom status bar indicates 'Seite 1 von 1, Elemente 1 bis 11 von 11. Gehe zu Seite 1 von 1 Ausführen Elemente pro Seite: 11 Ändern'.

KANiO 4 Ressourcen

Dashboard Betriebsführung Auswertung Stammdaten Dokumente

Home / Stammdaten / Ressourcen

Standardkonfiguration: Ressourcen - lokal Untergeordnet

Ressourcen

- Fahrzeuge (8)
 - Wasseraufbereiter (2)
 - Saugwagen (2)
 - Sinkkastenreiniger (2)
 - Sinkkastenreiniger 1
 - Sinkkastenreiniger 2
 - Pritschenwagen (5)
 - HD-Kombi (1)
 - Kanalfernaug (2)
 - Laborfahrzeug (1)
 - PKW (3)
- Sachmittel (5)
 - Mehrgas-Meßgeräte (2)
 - Aluminium Dreibock (3)
 - Roll- Gliss (6)
 - Sicherheits- und Auffangeschirr (22)
 - Selbstretter (11)
- Personal (5)
 - Team 1 (2)
 - Mitarbeiter 6
 - Mitarbeiter 8
 - Team 2 (2)
 - Team 3 (3)

Filter hinzufügen

Name
S 2696 - 2282
S 3255 - 2294
S 3356 - 2296
S 3245 - 2285
S 3177 - 2286
S 3229 - 2281
S 3178 - 2290
S 3191 - 2029
S 3189 - 2273
S 3246 - 2277
S 3176 - 2279

Person - Mitarbeiter 6

Konfiguration Personaldaten **Ressourcentyp** Tätigkeiten Termine Aufträge Ergebnisse

Ressourcentyp
Personal

Eigenschaften

- Abteilungsleiter
- Abwassermechaniker
- Abwassermeister
- Elektriker
- Führerschein Klasse B
- Führerschein Klasse C/CE
- Gruppenleiter
- Schlosser
- Schweißschein

/intern/Forms/PERSONAL_0.aspx?datatypeid=2001&compStorage=N&id=44780

Seite 1 von 1, Elemente 1 bis 11 von 11. Gehe zu Seite 1 von 1 Ausführen Elemente pro Seite: 11 Ändern

KANiO® Resource management

DESCRIPTION

In resource management, all resources can be organised and the necessary information can be added, such as qualifications and properties. The term Resources generally refers to personnel, vehicles and equipment.

YOUR BENEFITS

Direct access to all information relating to the resources, including for deployment planning:

- Personnel (qualifications, aptitudes, certifications)
- Vehicles (vehicle master data, vehicle documents)
- Equipment (detailed info, test schedules, etc.)

APPLICATIONS

Besides the allocation of resources to the pending tasks, tasks can also be organised directly on the resources, e.g., vehicle MOT dates or testing of certain devices. Equipment such as test instruments or ladders must also be inspected regularly, and this can also be scheduled directly in KANiO®.

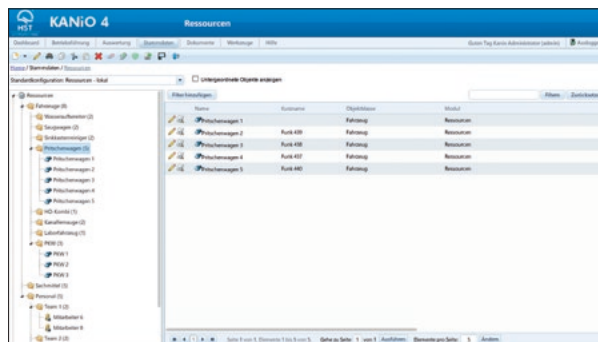

Resource management

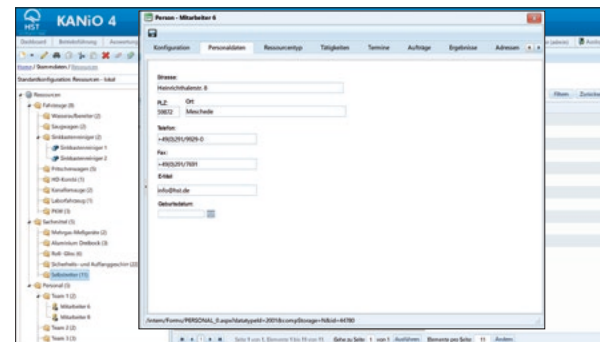

Resource details

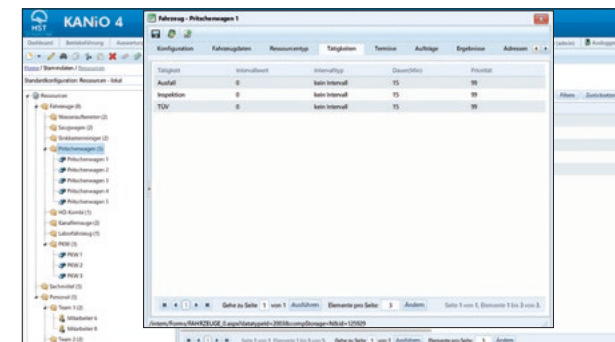

Resource allocation

KANiO 4 Auftragsverwaltung

Dashboard | Betriebsführung | Auswertung | Stammdaten | Dokumente | Werkzeuge | Hilfe

Guten Tag Kanio Administrator (admin) | Ausloggen

Home / Betriebsführung / Auftragsverwaltung

Standardkonfiguration: Aufträge - lokal

Aufträge

- Erstellt (14)
 - KW 16/2018 (6)**
 - HRB Kontrolle wöchentlich
 - Pumpwerkswartung PW Mühlenweg
 - Reinigung Netzgebiet 2
 - Schachtkontrolle Kirchstraße/Grabenweg
 - Schachtkontrolle Uferstraße
 - Sonderreinigung - Marktstraße Geruchsbelästigung
 - KW 15/2018 (2)
 - Schachtkontrolle Luisenstraße
 - Schachtkontrolle Marktstraße
 - KW 14/2018 (2)
 - Pumpwerkswartung PW Bahnhofstraße
 - Schachtkontrolle Bahnhofstraße
 - KW 11/2018 (1)
 - KW 03/2018 (1)
 - KW 37/2017 (2)
 - KW 34/2017 (4)
 - KW 33/2017 (2)
 - KW 21/2017 (15)
 - KW 20/2017 (1)
 - KW 29/2016 (4)
 - KW 18/2016 (5)

Quittierung

Ergebnisse erfassen | Quittieren | Teilquittieren

Auftragsinformationen | **Quittierung** | Eingabehilfe

Termine

Status	Termin	Anfang	Dauer (Min)
<input checked="" type="checkbox"/>	▼ Pumpe 1, Kontrolle Pumpe	16.09.2020 07:15	15
	Ergebnisname	Ergebniswert	Einheit
	Kontrolle durchgeführt		
	Probelauf durchgeführt		
	Folgeaufgabe notwendig	Nein	
	Bemerkung		
	Datum	16.09.2020	
	Dauer	15	min
<input checked="" type="checkbox"/>	▶ Pumpe 2, Kontrolle Pumpe	16.09.2020 07:30	15
<input checked="" type="checkbox"/>	▶ Pumpe 3, Kontrolle Pumpe	16.09.2020 07:45	15

Abgezeichnet/Intern quittiert: 20.04.2018 | Name/Unterschrift: Kanio Administrator

/intern/CompanyManagement/TMDialogs/Confirmation.aspx?jobId=227346

Seite 1 von 1, Elemente 1 bis 6 von 6. Gehe zu Seite 1 von 1 | Ausführen | Elemente pro Seite: 6 | Ändern

KANiO® Support for project planning

DESCRIPTION

With order management, you can arrange orders individually based on their content and scope, as the employee concerned is to process them. The KANiO® order assistant helps with the compilation and guides users through the individual process steps. The orders may consist of one or more deadlines, and may also include further information such as intervals cost centres or stock items. With KANiO® order management you have an overview of all orders which have already been created, partly fulfilled and confirmed. The current processing status is also displayed as the live status.

YOUR BENEFITS

- Central module for creation, material planning and monitoring of orders
- Optimum support for compiling orders with an order assistant
- Processing state displayed as live status
- Resubmission function for recurring processes

APPLICATIONS

Orders are created and planned in order management. The operational business in KANiO® converges on this central point in the system. The system also lends itself very well to decentralised work preparation. The user can search for all issues using the wide range of filter options. For example: In which street are which measures being carried out? Export to mobile devices such as tablets is also carried out in order management.

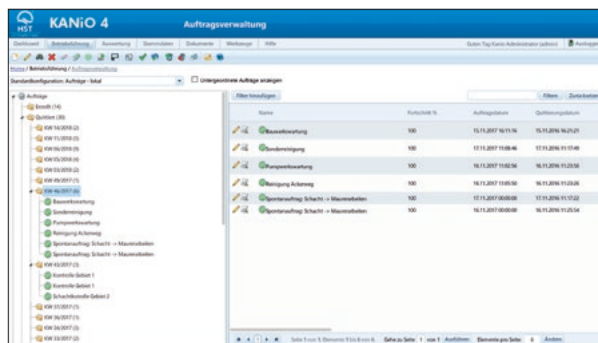

Order management

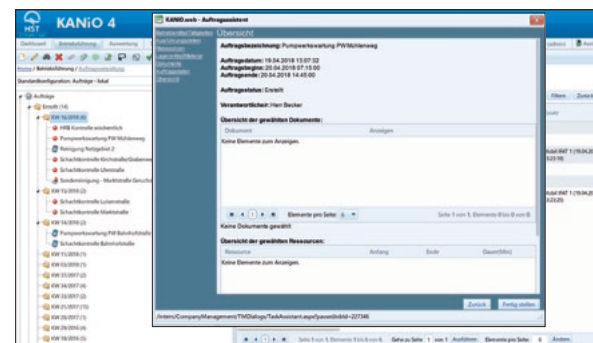

Overview of order assistant

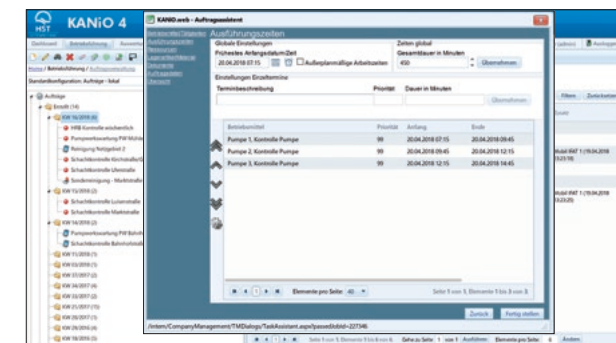

Incident logging

The screenshot displays the 'Workflows' section of the KANiO 4 software. The interface includes a top navigation bar with the HST logo and 'KANiO 4' title. Below this is a menu with options like 'Dashboard', 'Betriebsführung', 'Auswertung', 'Stammdaten', 'Dokumente', 'Werkzeuge', and 'Hilfe'. The user is logged in as 'Administrator (admin)'. The main content area is titled 'Störmeldungen' (Incident Reports) and contains a table with the following data:

Bezeichnung	Status	Workflowdatum	Bearbeiter	Art der Störung	Straße	Betriebsmittel
Störmeldungen 03.04.2018 12:00:33	Bearbeitung	03.04.2018 12:00:33	Herr Müller	Verstopfung Hausanschluss SW	Hauptstraße	PA0805HR02
Störmeldungen 27.03.2018 12:11:08	Bearbeitung	27.03.2018 12:11:08	Herr Müller	Geruchsbelästigung	Bahnhofstraße	81R0070
Störmeldungen 27.03.2018 12:02:30	Bearbeitung	27.03.2018 12:02:30	Herr Müller	Geruchsbelästigung	Eichenweg	70S3105

Below the table, there are two sections for pagination: 'Resultierende Aufträge' (Resulting Orders) and a summary bar. The summary bar shows 'Seite 1 von 4, Elemente 1 bis 50 von 172.' and 'Gehe zu Seite 1 von 4'. The 'Resultierende Aufträge' section shows 'Seite 1 von 1, Elemente 0 bis 0 von 0.' and 'Gehe zu Seite 1 von 1'.

KANiO® Workflow

DESCRIPTION

Additional to all planable tasks KANiO® supports the consideration and documentation of unpredictable, spontaneously occurring events or the inclusion of certain process sequences. For this purpose, within the workflow module, individual process sequences, such as a fault message detection or a home connection process are mapped. During the fault message detection, detected deficiencies or states are recorded by means of simple input masks, which can be configured individually for the respective operation, and forwarded for further processing. The messages can then be sent to the person responsible for the operation, e.g. the triggering of follow-up actions takes place.

YOUR BENEFITS

- Individual configuration of the entry mask
- Fast input and direct documentation
- All planable and unpredictable measures combined
- Direct triggering of follow-up activities

USE

You spontaneously notice damage to a system and want to record and forward it? The acquisition mask, which is individually tailored to the operation, offers the possibility of quickly and easily recording this message and forwards it to the responsible employees, also by means of an e-mail function. Due to the type of message and associated priority, a follow-up action can be initiated and executed.

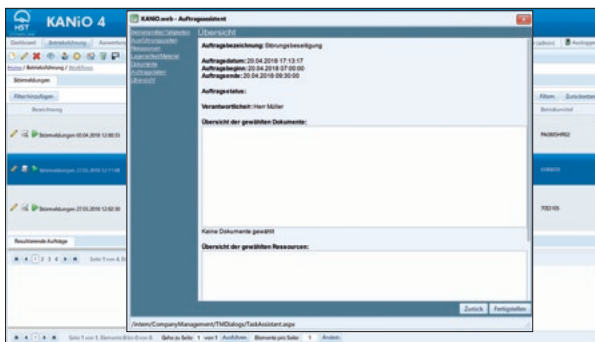

Order creation

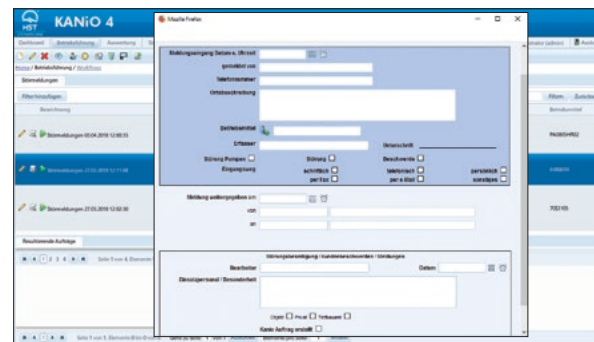

Individual input masks

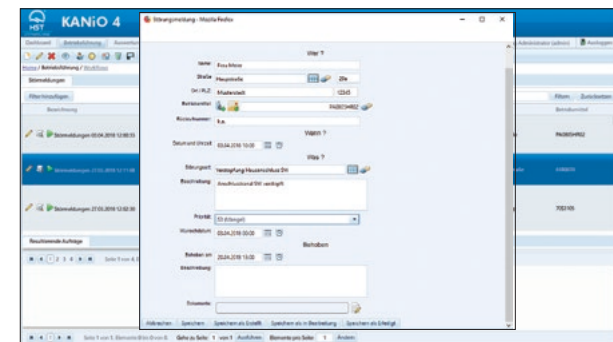

Fault detection



Netzauswertung von: 01.01.2018 bis 30.04.2018

Gereinigt wurden insgesamt 84 von 186 Strassen im Unterhaltungsgebiet
 Dies entspricht einer Reinigungsleistung von 360 km von insgesamt 800 km im Unterhaltungsgebiet
 Die Reinigungsleistung im Einzelnen :

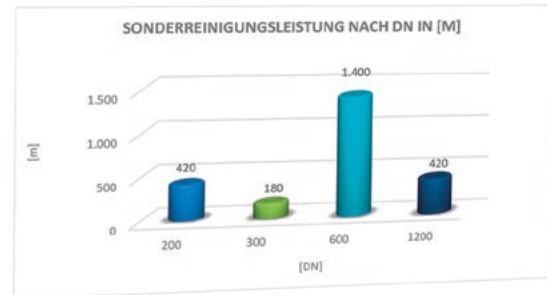
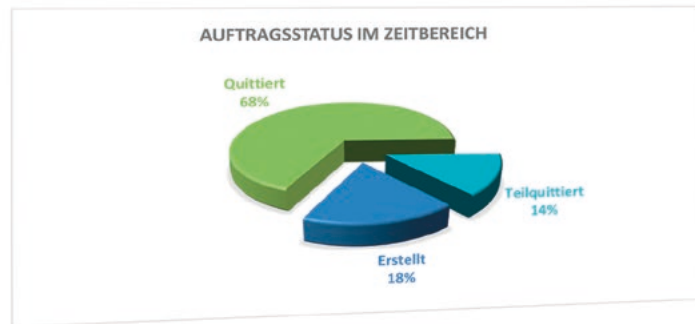
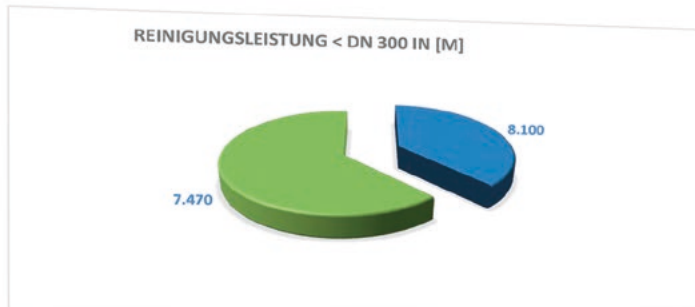

Personalstunden Unterhaltungsreinigung: 143,50 Stunden

Fahrzeugstunden Sonderreinigung: 79,75 Stunden

KANiO[®] Reporting

DESCRIPTION

Do you want an individual evaluation which supplies you simply with an overview of individual plants or complete sections of the network? With the KANiO[®] evaluation options, you have the capability to evaluate and display the information needed very quickly. Queries can be generated, for example, using prepackaged evaluation forms or simple filter queries. The evaluation can be presented in graphic or table form.

YOUR BENEFITS

- Fast information
- Direct answers
- Export functions

APPLICATIONS

Cleaning operations have been carried out in the network during a given period of time and in the course of these activities various results such as deposit heights or damage were collected. The KANiO[®] evaluation functions offer you individual analysis options. For example, you can create a connection between damage detected in two adjacent sections of the network, from which you can develop a solution for fault elimination or optimisation.

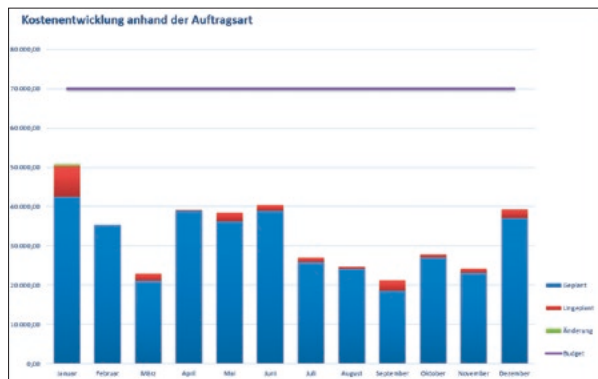

Cost trend

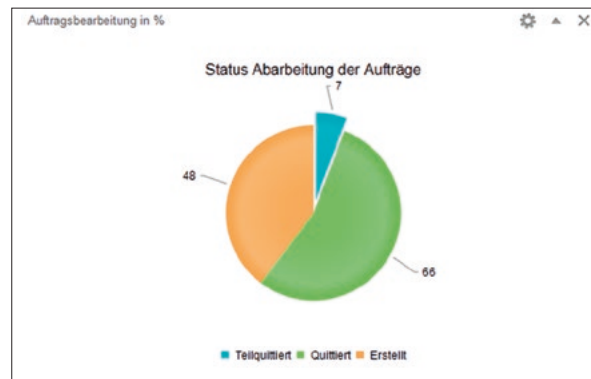

Order processing

Überwachungsbericht SewVO Abw
PW-Abwasserpumpwerke / Hochwasserpumpwerke
Berichtsjahr (BJ): 2017

Abwasserpumpwerke	Zustand des Anlagenzustand			Hochwasser- und Überflutungsvorwarnung			Anzahl der Überflutungen im Berichtsjahr					
	Erhaltungszustand	Nachrüstungsbedarf vorhanden	Hochwasser- und Überflutungsvorwarnung vorhanden	lokale	fern	Netz	lokal	mobit	Anzahl	Anzahl	Anzahl	Anzahl
PW Bahndorferstraße	x	N	N	x	x		4	4	0	4	0	0
PW Mühlenerfeld	x	N	N	x	x		4	4	0	4	0	0
PW Hauptstraße	x	x	J	x	x		4	4	0	4	4	4
PW Kleinhausen 1	x	N	N	x	x		4	4	0	4	4	4
PW Kleinhausen 2	x	N	N	x	x		4	4	0	4	4	4
PW Großberg 1	x	N	N	x	x		4	4	0	4	4	4
PW Großberg 2	x	N	N	x	x		4	4	0	4	4	4
PW Großberg 3	x	N	N	x	x		4	4	0	4	4	4
PW Lindenstraße	x	N	N	x	x		4	4	0	4	4	4
PW Bucherweg	x	N	N	x	x		4	4	0	4	4	4
PW Eichenweg	x	N	N	x	x		4	4	0	4	4	4
PW Schulstraße	x	N	N	x	x		4	4	0	4	4	4
PW Parkstraße	x	N	N	x	x		4	4	0	4	4	4
PW Nordbahnhof	x	N	N	x	x		4	4	0	4	4	4
PW Südbahnhof	x	N	N	x	x		4	4	0	4	4	4

Monitoring report



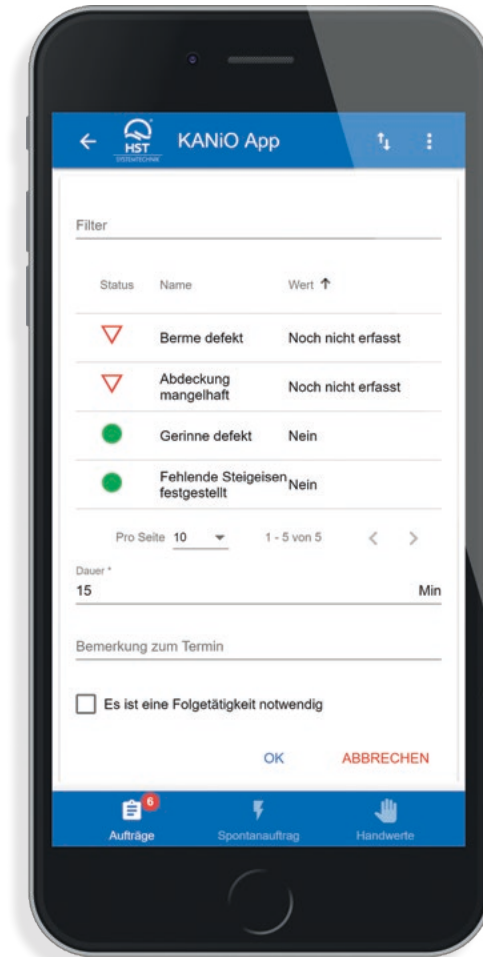
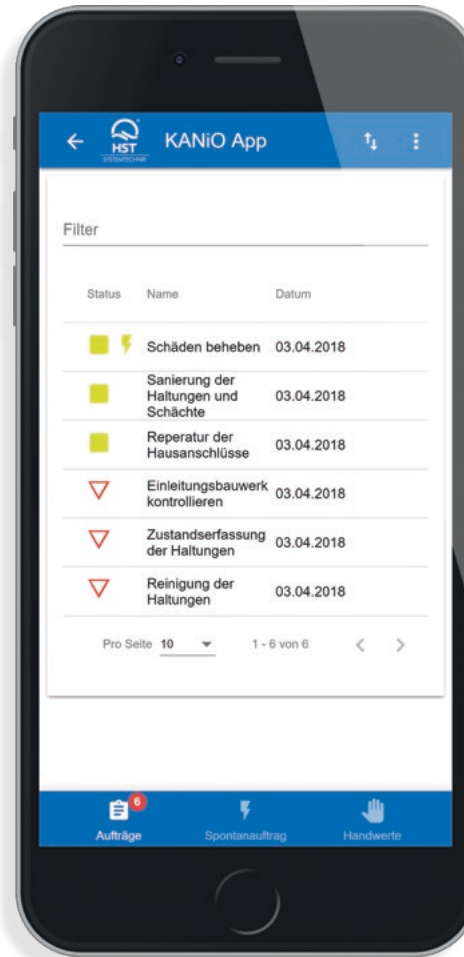
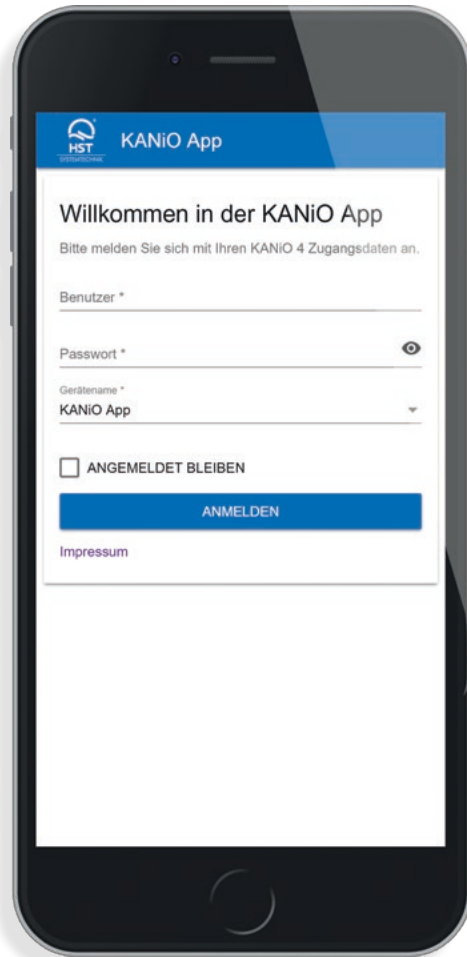

KANiO[®] mobile APP

Smart mobility with the KANiO[®] app

Depending on the use case, either the classic KANiO[®] mobile solution for tablets or notebooks with a Windows operating system or the platform-neutral KANiO[®] mobile app can be used. The KANiO[®] mobile app is able to run on practically all smartphones and tablets, providing a mobile solution that fits in your jacket pocket.

The KANiO[®] mobile app is used for order processing in the field and also includes the option for logging spontaneous orders. In this way, defects can be processed and documented as soon as they are detected. The KANiO[®] mobile app is ideal for logging count values, measurement values or other values which have to be entered manually. Now is your opportunity to replace the analogue world of paper records with a digital solution, and manage documentation reliably and without mistakes in future.

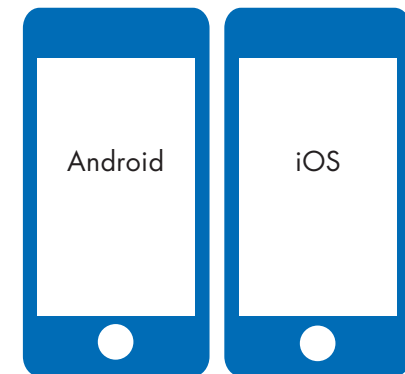

For operation, maintenance and servicing

The Stadtwerke Borken public utilities company in Borken/Westfalen achieved certification with the aid of KANiO®

The required standards were very high. Stadtwerke Borken/Westfalen set themselves the objective of obtaining technical safety management certification according to G1000, W1000 and S1000 for their operations. An ambitious objective; after all, the project could not even begin until data enhancement and systematic collection and networking of all operational documents, software and work processes were in place. And throughout the process of course, the safe, reliable, cost-efficient supply of electricity, natural gas and water to the town of Borken and the surrounding communities must not be compromised at any time. So

the task was extremely challenging, since prior to that time many software solutions were in use in Borken. Applications such as the Navision commercial system, the Autodesk Mapguide geographic information system, the process control technology and the standard Office applications supported workflows throughout the company.

But as reasonable as these software solutions were individually: Over the years, problems had arisen more and more frequently as a result of technical advances and the corresponding extensions. The main

reasons included the increasing volume of data and data sources and a lack of standardisation. For this reason, the public utilities companies were initially sceptical as well: Can there be an operations management system which is able to merge the existing quantities of data, spreadsheets, documents and other working aids, so that all facilities and plants can be run efficiently and safely? How can the various paper forms for capturing data and documentation be replaced by one software program which simultaneously manages all data capture via mobile field devices in conjunction with a graphical mobile

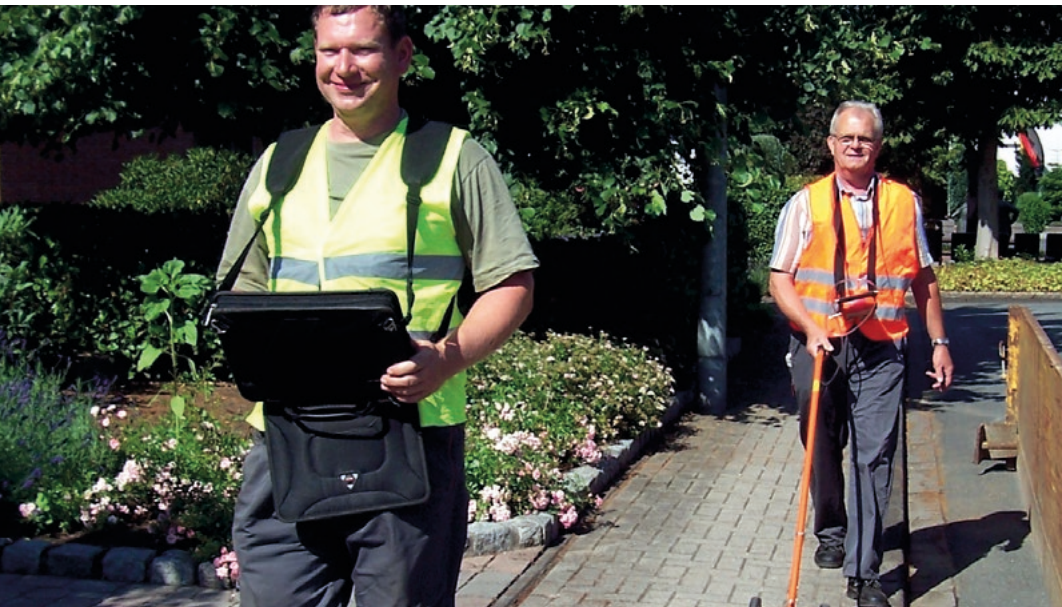

planning component? And: Can it be used to enhance the entire data stock and so help Stadtwerke Borken achieve its certification objectives?

Ideally, the new operations management system should be capable of being integrated into the existing system environment and offer a high standard. Connection to the existing Autodesk Mapguide GIS assumed critical importance. For this reason, the first step was to examine the existing systems. However, it became evident very quickly that the systems in place were only capable of satisfying a fraction of the

functional scope required. An IT-supported operations management system was imperative. It should also be a standard application, with the great advantage over stand-alone developments of enabling the existing functions to be used directly. This is perfectly in keeping with the general trend: away from individual solutions and towards proven standard developments.

Now the next step was to test the operations management systems available on the market. The decision was finally made in favour of KANiO® from HST. Within a very short time, the entire operations,

servicing and maintenance management system for electricity, gas and water supply in Borken with all facilities and technical equipment was switched to KANiO®. In view of its successful deployment, it is already planned to extend the use of KANiO® to other areas of the company, such as swimming pool operations management and street lighting.

Cleaning only when necessary

Munich city drainage: Less work and reliable documentation in sewer operations

The mere transition to an individual, schedule-based sewer cleaning system helped the Münchener Stadtentwässerung (MSE) to realise enough savings to defray the costs of introducing the KANiO® operations management system. At the moment, the sum assigned annually by MSE internally using KANiO® is more than three million euros and continues to rise. Transparent operations management documentation with KANiO® also ensures that MSE is prepared for the requirements of the future with a legally substantive, verifiable system. Finally, the result convinced everyone, even though the customer's requirements for KANiO® were initially extremely stringent. At the beginning of the new millennium,

the enormously diverse tasks which MSE carries out to ensure the function of the network were placed on the test bench. Particular attention had to be directed to the new challenges imposed by the Self-Monitoring Ordinance, legal certainty and quality management. As a result, optimisation potential was discovered, which was to be corrected using new strategies and modern technologies. For example, the operations management system (OM system) should support practically all technical processes in the context of maintenance management.

All 2400 kilometres of the sewage network in the city of Munich is divided into zones and subzones. In turn, there are flushing segments within the subzones which consist of retention objects of varying sizes. Cleaning intervals during operation have already been established for the flushing segments contained here, and these specify repeating the process with the following intervals: every year, every two years, and every four years.

The intervals are fixed on the basis of the existing, extensive knowledge and experience of the sewer cleaning personnel. In the past, the cleaning intervals were recorded in separately managed Excel spreadsheets. With

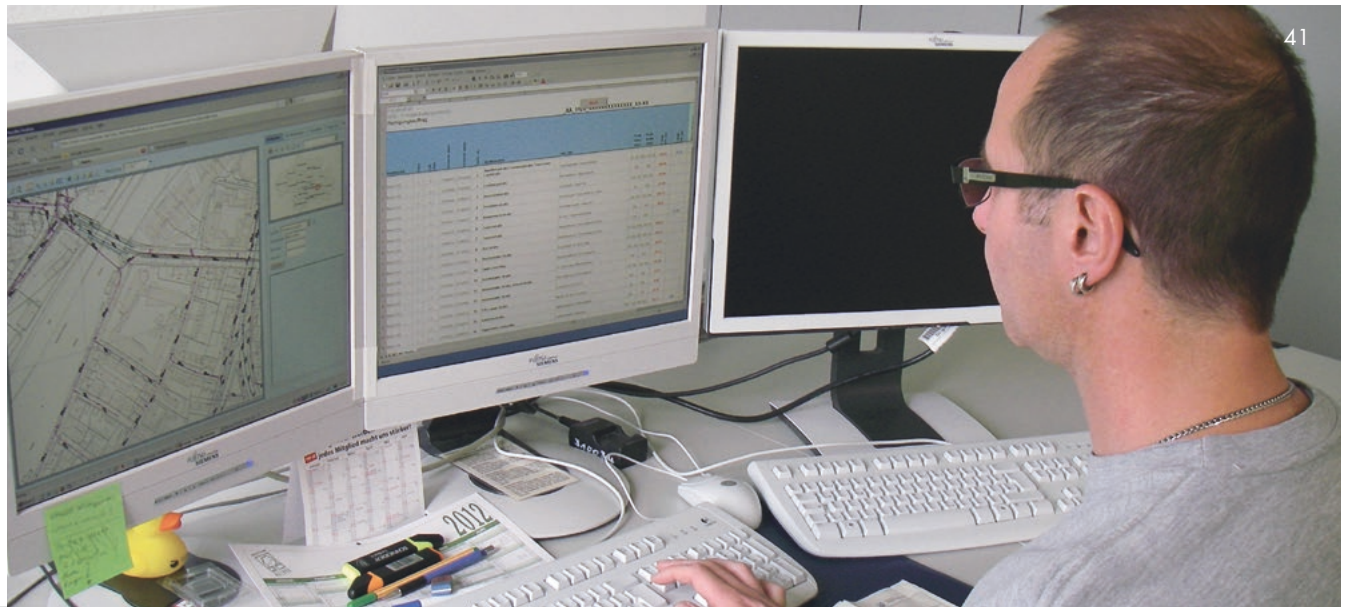
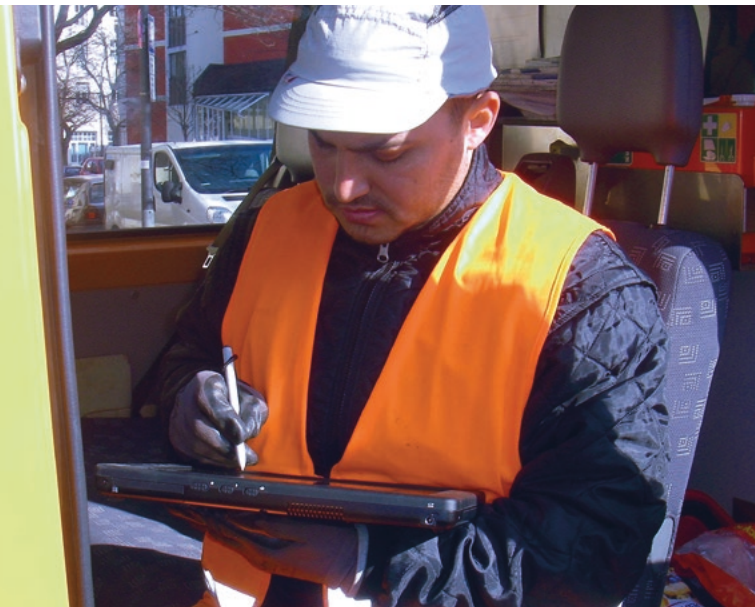

the introduction of the OM system, this valuable characteristic data was transferred to the central OM system database once and for all. Together with the sewer master data supplied by the network information system, they provide an excellent data basis for operations.

Convenient filter tools in KANiO® based on the existing basic data enable simple compilation of the cleaning and inspection orders. Cleaning orders for each individual subzone are created, for example. The corresponding retaining systems - packed in flushing segments - can then be listed as commissions according to the

schedule using appropriate filters. The cleaning orders were initially output on the customary paper forms. The responses regarding completion of the cleaning tasks then serve as the basis for changing and optimising the existing intervals. In this way, the plan is always based on a continuous improvement process as required for quality management.

After the productive introduction of the OM system in the individual operational areas of MSE, in 2011 they began thinking in specific terms about the transition from a manual order system to order processing via mobile

recording devices. The basic coordination for this had been implemented earlier, when the requirements the mobile KANiO® application was to meet during operations were defined in a comprehensive practical test. The basic data determined for this was incorporated in the procurement of the mobile hardware and the graphic viewer. The performance features defined on this basis enable employees to create documentation more easily and faster, and provide valuable support for their processes in the network.



KANiO[®] ISMS tool

IT security management for water management

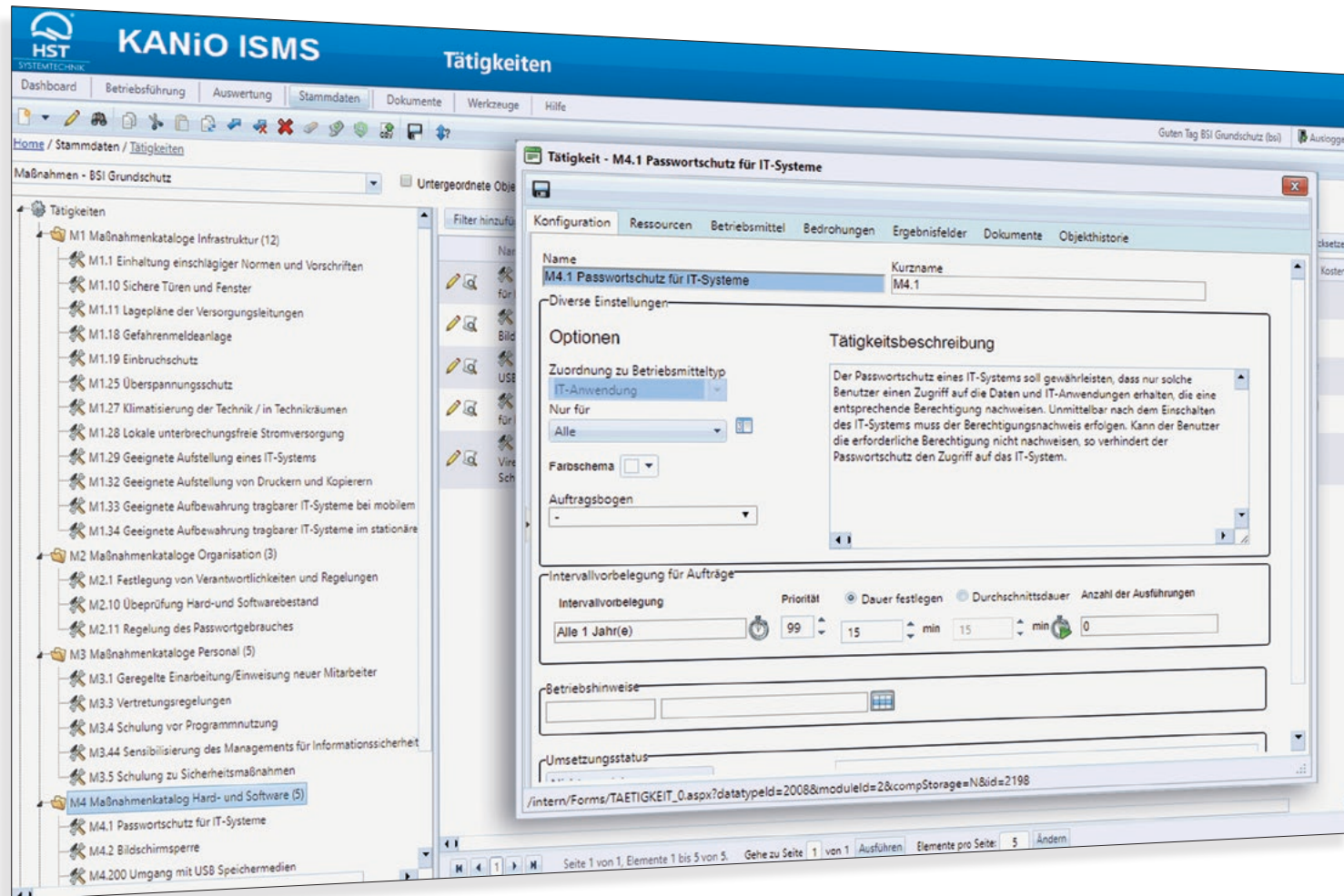

KANiO[®] ISMS tool IT security management for water management

The management system for ensuring your IT security

Information security serves to protect information that is critical for the organisation or information that must be protected by law from being changed, misused, lost or destroyed. The implementation and constant maintenance of IT security presents an enormous challenge for many operators of water management facilities, and this challenge is often met by engaging external IT experts. Experience has shown that this practice seldom leads to the desired results, because the IT specialists do not have the requisite knowledge of the processes involved in water management and the facility operators are not familiar with the language of the IT specialists.

HST has been providing equipment to water management facilities for more than 35 years, and has the expertise regarding processes and technical proce-

dures in water management facilities as well as the technological know-how in information technology. You can be sure that we will speak the same language in a joint project.

Managing IT security properly

KANiO[®] ISMS is the IT Security Management tool for water management. Its modular design and scalability make it possible to create a tailored solution for managing IT security according to current security standards. KANiO[®] ISMS supports the B3S industry standard, the current BSI-Grundschutz (IT basic security, Federal Office for Information Security) and the ISO 27001 standard.

KANiO[®] ISMS offers optimum support for organising your IT security management system. This starts with an inventory review and organisational analysis and includes a risk evaluation and the resulting planning

of essential security measures, and culminates in the practical implementation of the measures. KANiO[®] fully support the underlying PDCA cycle (Plan – Do – Check – Act) and thus reinforces the continuous improvement process that is a requirement of the IT security standards.

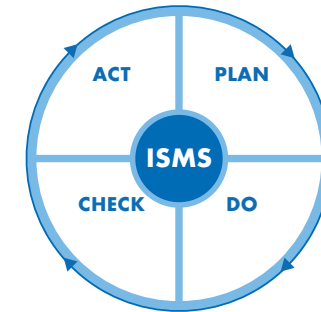

With the mobile KANiO[®] ISMS solution, the defined security measures can be processed systematically in the form of convenient digital checklists.

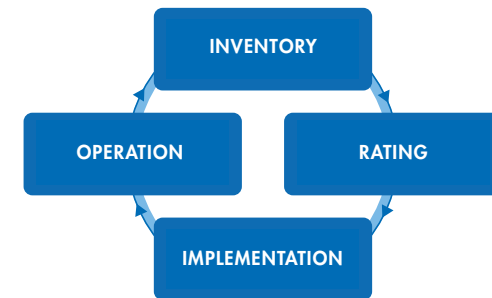
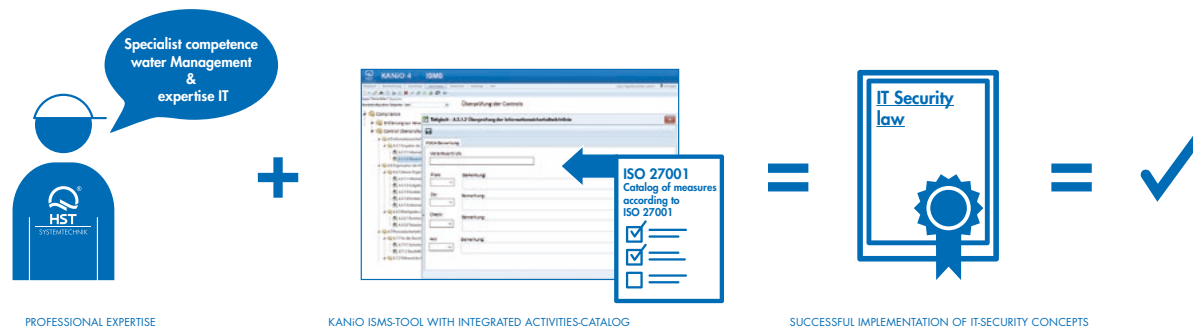

Implementation of the IT security concepts for municipalities

Asset	Risikobewertung	Bedrohung	Eintrittswahrscheinlichkeit	Tätigkeit	Verantwortlicher	Letzte Inspektion
SCADA Server 1	Warnung					
SCADA Bedienarbeitsplatz Leitwarte	Warnung					
SCADA Server 2	Warnung					
SCADA Software Server 1	Warnung					
SCADA Software Server 2	Warnung					
SCADA Server 1 (Master)	Sehr hoch	Datendiebstahl	monatlich	M4.200 Umgang mit USB Speichermedien	Hans Meier	16.11.2017 00:00:00
Leitwarte Wasserwerk	hoch	Einbruch, Diebstahl, Vandalismus	jährlich	M1.10 Sichere Türen und Fenster	Hans Meier	14.11.2017 00:00:00
Leitwarte Wasserwerk	hoch	Kommunikationsausfall durch Leitungsbeschädigung	jährlich	M1.11 Lagepläne der Versorgungsleitungen	Hans Meier	15.11.2017 00:00:00
Leitwarte Wasserwerk	hoch	Stromausfall durch Leistungsbeschädigung	jährlich	M1.11 Lagepläne der Versorgungsleitungen	Hans Meier	15.11.2017 00:00:00
Notebook für Bereitschaft	hoch	Datendiebstahl	täglich	M4.27 Zugriffsschutz für Notebook	Hans Meier	12.01.2018 00:00:00
SCADA-Software Wasserwerk	hoch	Datendiebstahl	jährlich	M4.1 Passwortschutz für IT-Systeme	Hans Meier	15.11.2017 00:00:00
SCADA-Software Wasserwerk	hoch	Unberechtigte Schalthandlung	jährlich	M4.1 Passwortschutz für IT-Systeme	Hans Meier	15.11.2017 00:00:00
USB Platte SCADA-System	Normal	Unberechtigter Zugriff auf Daten	jährlich	A.8.3.1 Handhabung von Wechseldatenträgern	IT-Administrator	10.08.2017 00:00:00
USB Platte Leitwarte	Gering	Datendiebstahl	jährlich	M4.200 Umgang mit USB Speichermedien	Hans Meier	27.02.2018 00:00:00

KANiO[®] ISMS tool IT security management for water management

RANGE OF SERVICES

- Professional consulting on current
- security standards
- Design of an ISMS according to the B3S industry standard, the current BSI-Grundschutz (IT basic security, Federal Office for Information Security) and the
- ISO 27001 standard
- Support by internal and external audits
- Conducting of weak point analyses
- Implementation of safeguards against
- Cyberattacks

KANiO[®] ISMS equipment

All security-critical assets are organised in KANiO[®] ISMS in a configurable tree. The protection needs defined in the tree view is represented directly with a coloured LED symbol.

KANiO[®] ISMS actions

In order to provide reliable IT security, actions are stored on the basis of the IT security standard selected. To ensure that a continuous improvement process can be maintained, an interval may be assigned to actions. In this way, a pending security check is initiated automatically and can be conducted conveniently on the basis of a digital checklist.

IT security status view

The current IT security status is available for viewing in KANiO[®] ISMS with the click of a mouse. For this, the current security status with regard to each threat detected for each item of equipment is displayed in the form of a traffic light symbol. In this way, all important data can be reviewed at a glance.

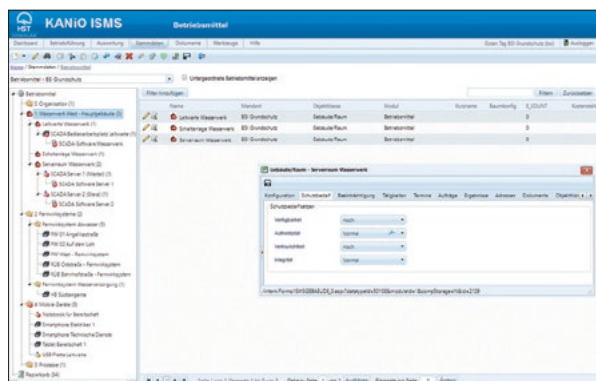

Protection need

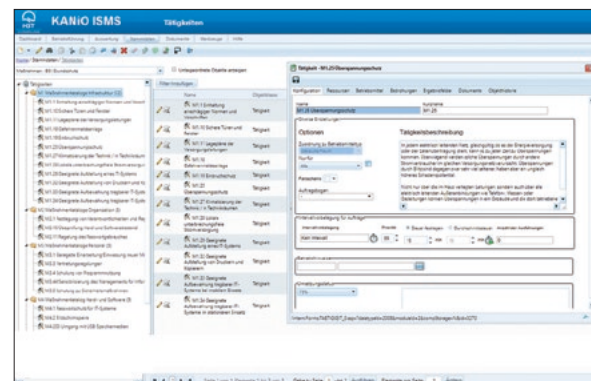

IT security actions



SCADA

Process control technology for the water and energy industry

OPERATION MANAGEMENT



KANiO® ISMS IT security management-system



KANiO® Operations management software portal solution



smartKANiO maintenance software for machines

TCP/IP, Internet ...

PROCESS CONTROL



SCADA V10 SCADA-Systems Client server solution



SCADA.web Process data prtal Portal solution



smartSCADA Software to control machines

... Windows, OPC, OPC-UA, IEC 6070, IEC 61131, IEC 61850 ...

AUTOMATION MONITORING OPERATION



IntelliSysteme machine and process control by data/sensors (IoT key components)



HydroMatic SPS-software modul for machine control



TeleMatic control and monitoring

... EtherCAT, PROFINET, PROFIBUS, Modbus

SMART MACHINES
Machines with special automation intelligence as smartSCADA and smartKANiO



AWS-Jet Cleaner with IntelliGrid



ASA-Weir with IntelliFlow

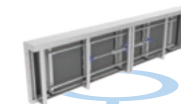

HSR-Screen with IntelliScreen

... Ethernet, WLAN, GPRS, UMTS, LTE

DATA/SENSORS



SensoMatic-EMA data capture



TeleCam Visual process control



NiRA.web® Precipitation portal

SCADA Systems

Process data – Added value through networking

Each facility and machine is like a complex organism. Processes and operations run in it that can only be understood if the necessary diagnostic data is available. In the first step, therefore, all important data must be recorded flawlessly to ensure that it can be usable and useful. Finally, the analysis of this data must ultimately allow an overall view of the process landscape and support optimisation of the processes.

Besides high-quality data recording using the delta event method, suitable analysis tools are needed for optimising the processes. The analysis tools from HST are designed for optimum compatibility with the processes employed in the water and energy industry. For example, additional information such as precipitation data or current levels are integrated directly from the cloud with the aid of IoT process variables. A great deal of positive feedback from the civil engineering and process engineering sectors prove that the HST solutions are appreciated in many situations for precisely these reasons.

SCADA systems – Developed by industry experts

SCADA systems from HST are unique because of their uncompromising industry orientation and constant, innovative further development. The close communication between the development team with our construction engineers, process engineers and the operators lends our SCADA systems an unmistakable mark of practical application. Thus, for example, the delta-event archiving method used for the first time with HydroDat V5.3 has now become a distinguishing industry standard.

Usability – The operator is king

One of the greatest challenges in information technology is that of reducing complex functions and relationships to forms which can be operated easily and intuitively. Our software designers have invested much commitment in addressing this challenge. Software products from HST are developed with modern development tools in accordance with current UI guidelines.

Process control technology

target group

- Sewage treatment plant
- Sewage network
- Water supply
- Flood protection

Sewage treatment plant

In order to monitor and document the sewage treatment process, SCADA systems from HST offer sophisticated analysis and evaluation tools. Besides a graphical analysis, various operations journals can be selected for logging. You can choose the one that you prefer. Networking with the NiRA.web® precipitation portal enables precipitation events to be forecast and incorporated in operations management.



Sewage network

HST places great importance on the monitoring of special structures in the sewage network, since HST as a market leader in rainwater reservoirs has acquired considerable expertise in this field. With our delta event method and a pure, undistorted system for archiving process data, rain events can be captured and evaluated by means of a clever networking arrangement. Rain events can be forecast early by networking with the NiRA.web® precipitation portal. The sewage network can then be prepared appropriately.



Water supply

The availability of the SCADA system is a primary consideration for the water supply. The supply of high-quality drinking water must be monitored at all times. This is why SCADA systems from HST are also installed redundantly as a high-availability system solution. SCADA V10 includes an effective function for monitoring pipe breaks and detects leaks with extreme certainty.



Flood protection

SCADA systems which are used for flood protection only have to be operated in emergencies. This entails particular requirements regarding the usability of the system. Information must be provided in unambiguous, clearly understandable form. Additional information about inflow levels and the precipitation forecasts and levels can be incorporated directly from the cloud using IoT process variables..



Process control technology

target group

- Transverse structures
- Gas supply
- Biogas plants
- Landfills
- Industry

Transverse structures

Security is the highest priority in monitoring transverse structures. This goal is achieved with the use of high-availability software solutions and a clearly structured user guidance. SCADA systems from HST are available in the form of a redundant hot-standby system or as a failover cluster. Their open system architecture allows video surveillance to be integrated directly.



Gas supply

SCADA systems from HST lend themselves exceptionally well to use by a utility supplier. The integrated multi-client capability enables operation analysis and alarms to be ensured for each segment completely separately with a single system. There is a special consumption forecast module for the gas supply.



Biogas plants

SCADA systems which are used to monitor biogas plants must provide suitable analysis and optimisation methods as well as the classic process monitoring capabilities. Optimisation for increased gas yield can only be achieved with correct data recording and the proper analysis tool. The integrated alarm management issues immediate information about imminent malfunctions and investments implicated thereby.



Landfills

Our landfills must be analysed and measured constantly to ensure that they can be operated safely and without endangering the environment. With its network connection to the precipitation portal NiRA.web®, SCADA V10 provides the best possible conditions for safe, focussed monitoring of landfills. The graphical evaluation tool is equipped with special analysis functions such as graphical analysis spanning decades.



Industry

Industry 4.0, the topic of the future: The intelligent factory will be characterised by its versatility, economical use of resources and ergonomic layout as well as the inclusion of customers and business partners in value added and business processes. Highly distinctive products and supremely flexible production (mass customization) will be its distinguishing ideas. The technological basis therefore is automation and process control technology, as well as the "Internet of Things". It already enables intelligent control of processes in industrial plants by connecting SCADA systems from HST with web technologies. The software processes data in such way that it is tailored precisely to the user's needs.





SCADA V10

Process control technology for the water and energy industry

VISUALISATION

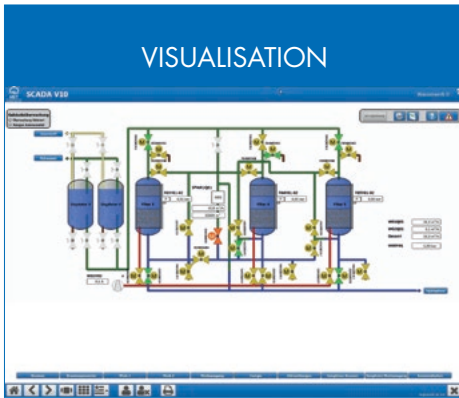

LOGGING



EVALUATION

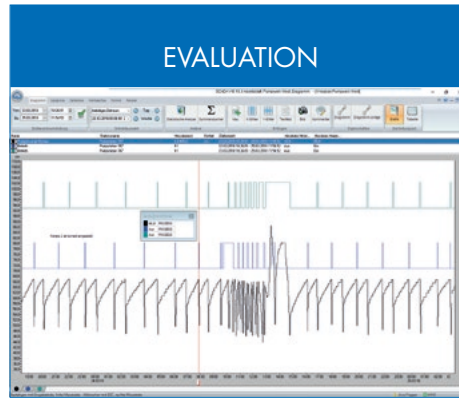

ALARM SYSTEM

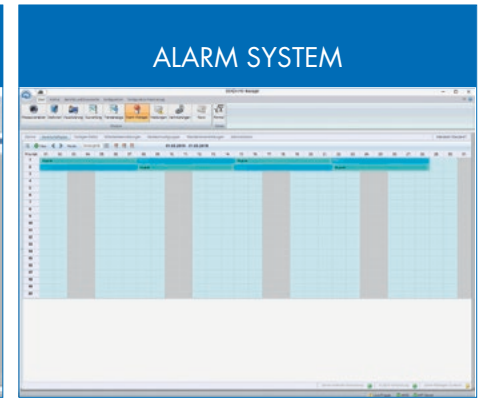

PROCESS IMAGE EDITOR

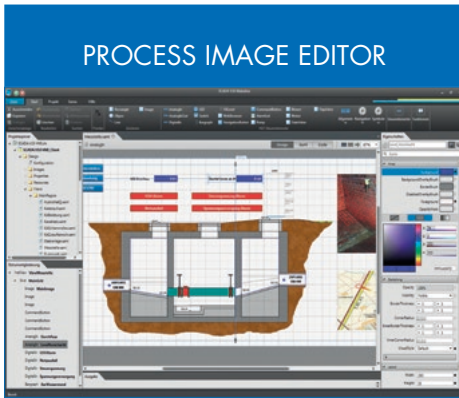

CONFIGURATION

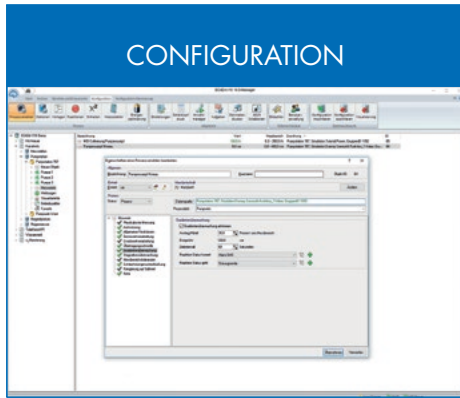

TREND & FORECAST

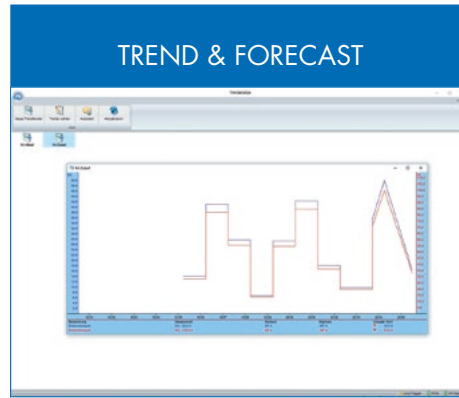

REGISTRATION BOOK

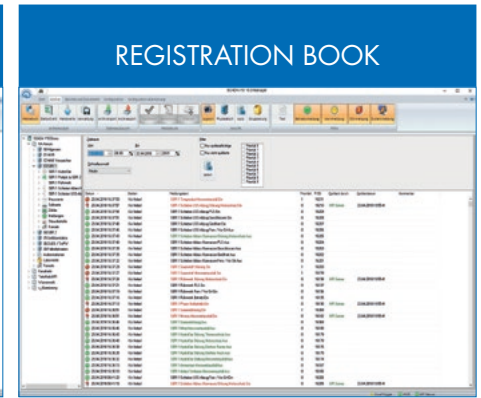

ENERGY OPTIMISATION

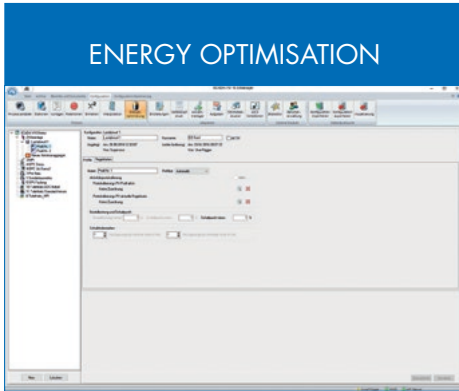

ARCHIVING

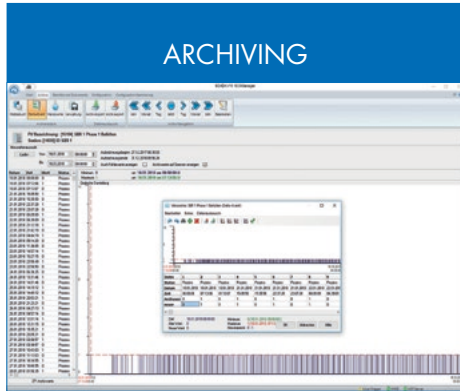

SCADA V10 Innovative process control technology from a single source

Innovative, safe and open for other systems

The user-friendly SCADA V10 process control system monitors and documents processes in central and remote facilities. The highly integrated SCADA package visualises all process data via a multitouch-capable visualisation unit, enables optimal graphical process analysis and includes fully comprehensive alarm management. The basis for logging apart from the statutory ordinances are the guidelines and regulations issued by the DWA (German Association for Water Management, Wastewater and Waste), for example M207, M253 and M260. SCADA V10 is the innovative, open-system process control system from a single source, which can also be integrated in networks with other IT solutions from HST. SCADA V10 is the Office suite for water management.

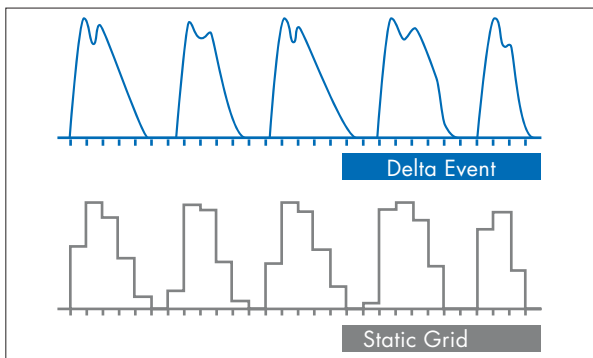

Delta event archiving
compared with grid archiving

Concentrating on the essential

SCADA V10 is set apart by the fact that it enables even complex relationships and functions to be operated easily and intuitively. The user interfaces are designed in such a way that important and frequently used functions are easy to access. The operating elements are located at the positions, so that all pertinent data is presented at a glance. Our insistence on ergonomic design applies to the entire system. SCADA V10 is created from a single source. This is the only way to ensure that the operating philosophy and terminology are uniform, and that a common, central data basis is provided.



Archiving after a delta event

The basis for all analyses is the quality of the data recovered. For this reason, SCADA V10 archives the data after the HST delta event method, thus ensuring the data basis is always in prime condition. The delta event method was established and refined by HST over 25 years ago. This flexible recording method ensures that each significant change is recorded and at the same time no unnecessary data is archived. Cyclical archiving of precipitation quantities in dry weather serves no useful purpose. On the other hand, it is imperative to have highly accurate recording in the event of an incident. Therefore, a recording procedure must respond to the dynamics of the process and specifically must not record average values in a static time pattern. Moreover, the delta event method can access all archive data since the archive recording began as raw data, and so is able to deliver a high-resolution analysis of historical data. If a grid archive is used, older archive data is only available in aggregate form.

SCADA V10 Versatile – modular - scalable

We placed particular emphasis on flexibility when designing the SCADA system. The process should not have to be adapted to the SCADA system, the SCADA system should rather be adapted to the given process. For this reason, SCADA V10 is equipped with many standard interfaces and communication options. For example the process can be connected directly via the network with TCP/IP or Profinet, via a fixed line, or across the internet (DSL/3G/4G). SCADA V10 also supports wireless communication such as "Industrial WLAN" or time slot radio.

There are many drivers available for connecting the automation or telecontrol level. The SCADA system itself can be set up as a single-user system, a client-server system or as a cluster system.

The user workstations can be integrated as classic Windows workstations or also as web workstations.

For on-call services, there are web-based operation clients and web applications optimised for use on smartphones and tablets.

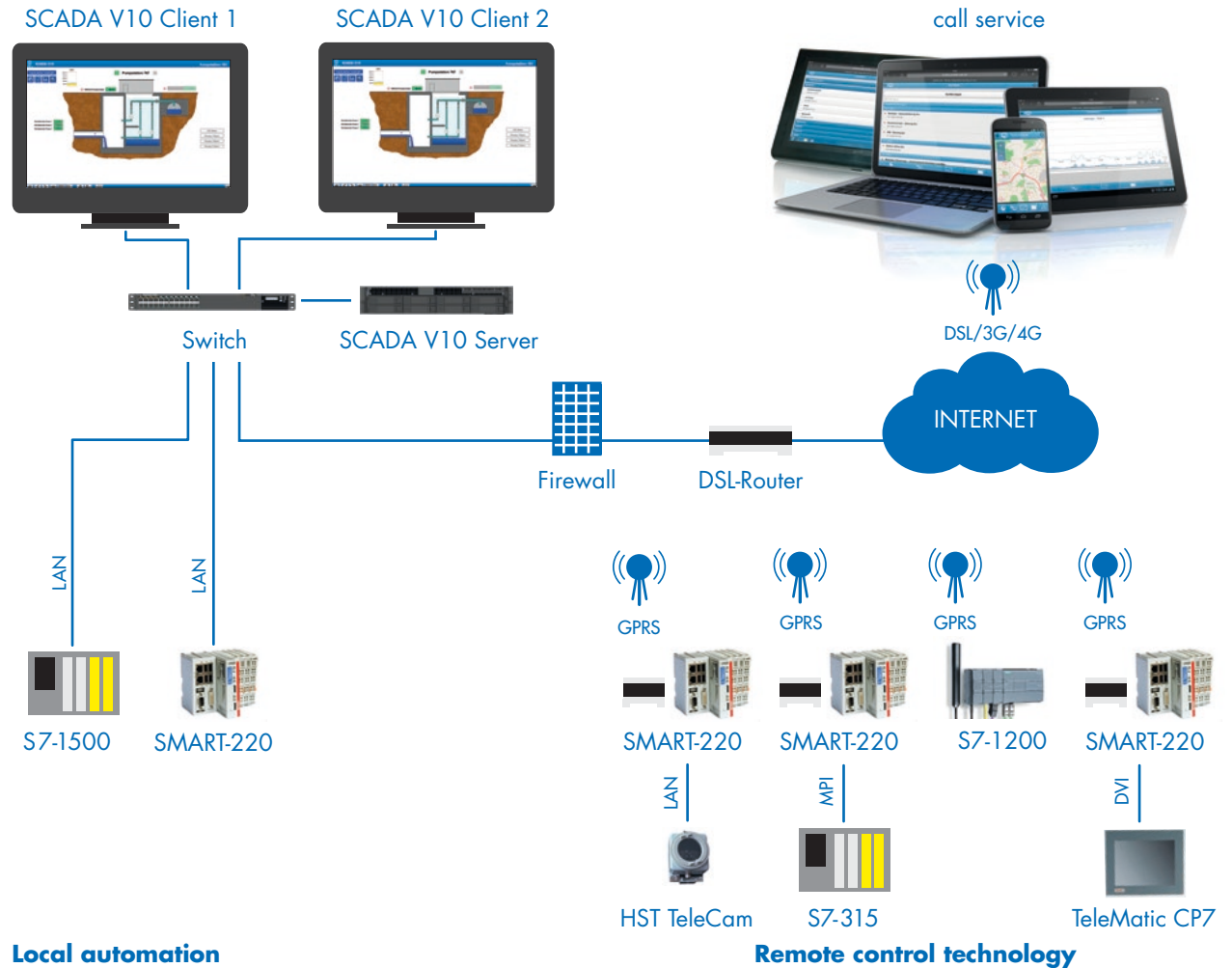

SCADA V10 Cascaded system solution for associations

Water and wastewater associations operate a larger number of sewage treatment plants, waterworks and decentralised facilities. They are therefore particularly interested in the subject of networking. With SCADA V10, individual plants can be equipped autarchically with a SCADA system and also communicated with a higher-level control centre. In this way, all required process data from the subordinate systems is also available on the higher-level control system and can be taken into account for purposes of a higher-level perspective. For example, higher-level reporting or superordinate alarm management can be implemented in this way.

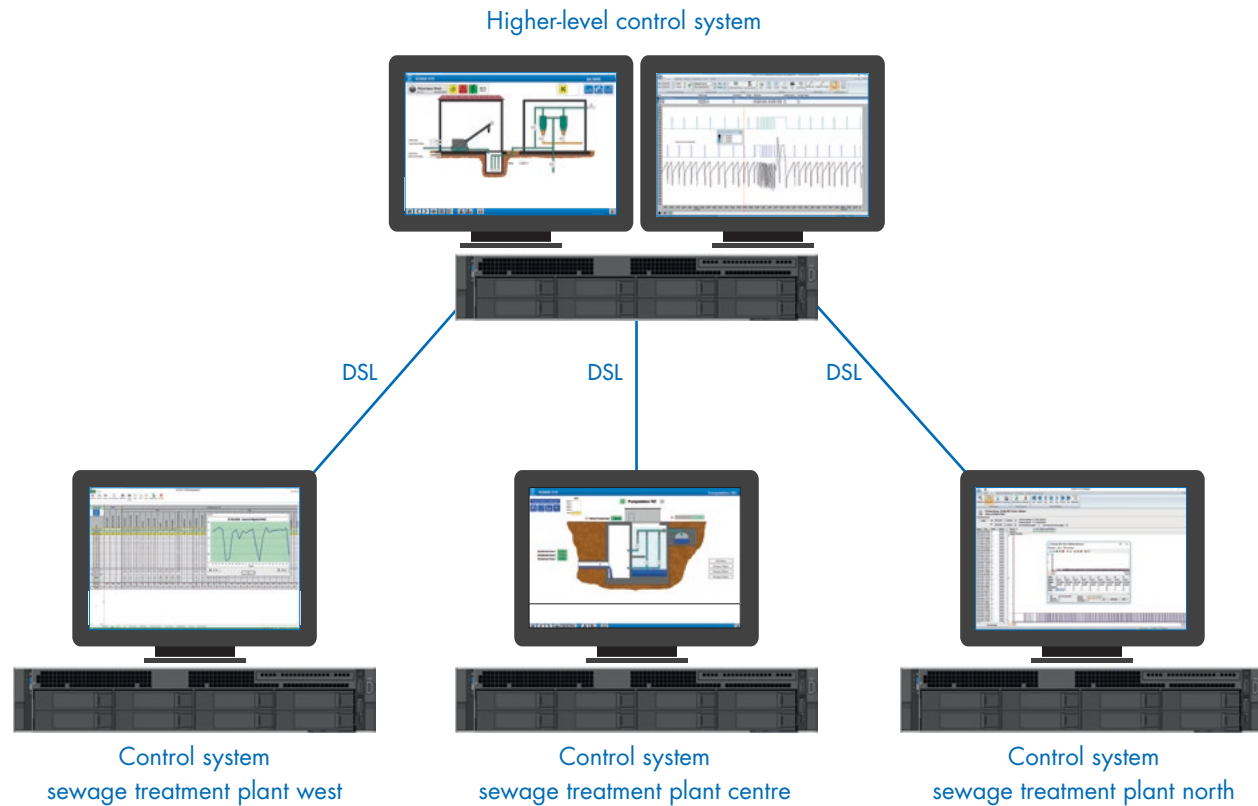

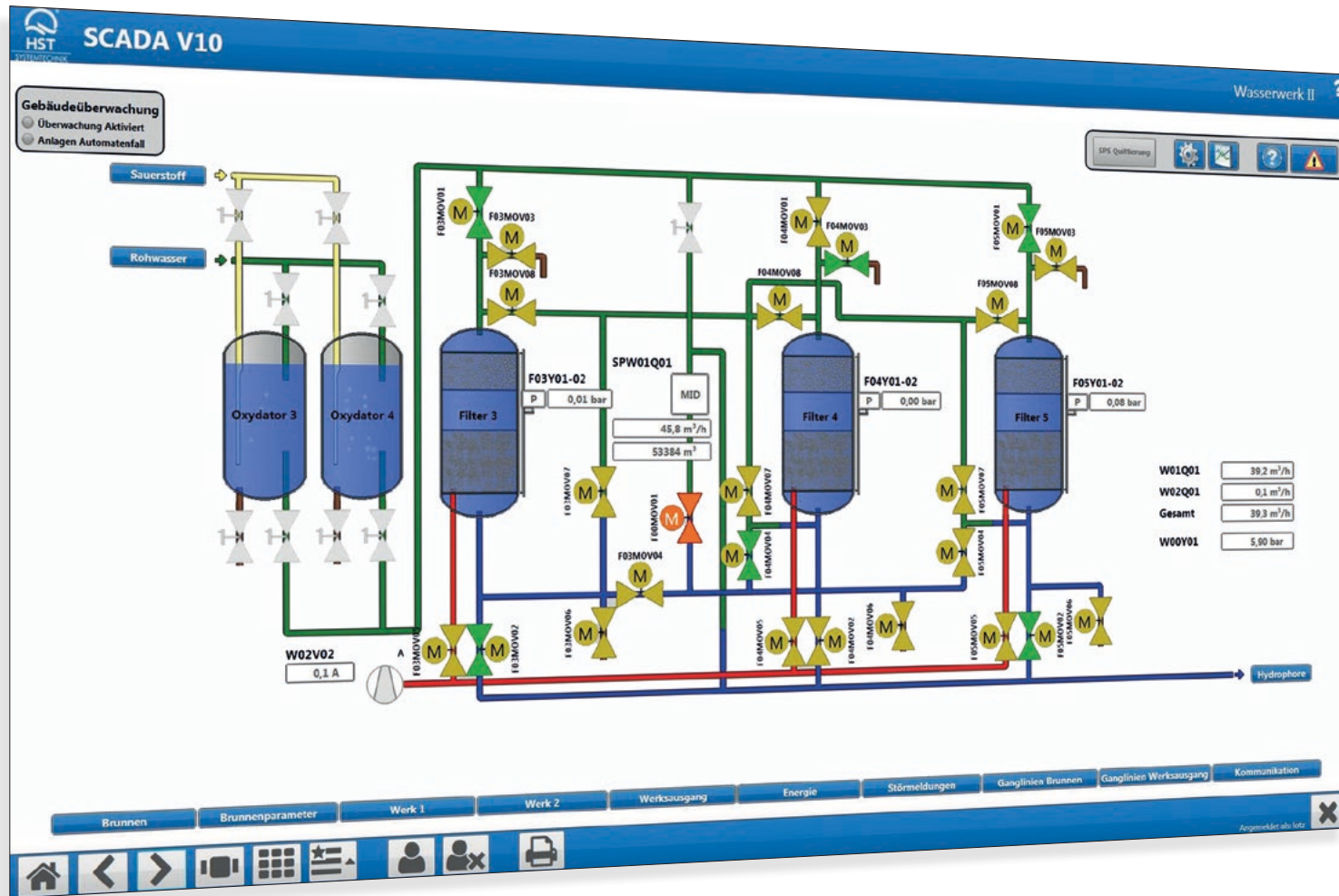

SCADA V10 Visualisation and operation

PRODUCT DESCRIPTION

The visualisation of the processes is often at the heart of a process control system. SCADA V10 is a fully integrated SCADA system, not a visualisation which has been completed with various add-on products. The result of this integration is remarkable and manifests itself particularly in its interaction capabilities. For example, the registration book, the configuration, the graphical evaluation, the documentation and of course the reporting system can all be accessed directly from the visualisation. But conversely as well, the associated process image can also be called directly from the registration book, the configuration or the graphical evaluation.

With the SCADA V10 visualisation, the process is the most important factor. For this reason, superfluous operating elements have been dispensed with. Operation is intuitive and context-driven. If the user moves the mouse point to a display element, a window with additional information opens automatically. The hydrograph, the registration book or the configuration of the process variable can be called for any display element directly from the visualisation. For optimal display of the visualisation on monitors with different resolutions, the size of the visualisation is freely scalable. Modern technologies such as multitouch operation and 3D imaging are also supported.

YOUR BENEFITS

- Simple, intuitive operation
- Freely scalable process images
- Integrated connectivity functionality
- Object library for units and machines
- Multitouch-capable
- High-functioning image editor
- Programming interface (Visual Studio)

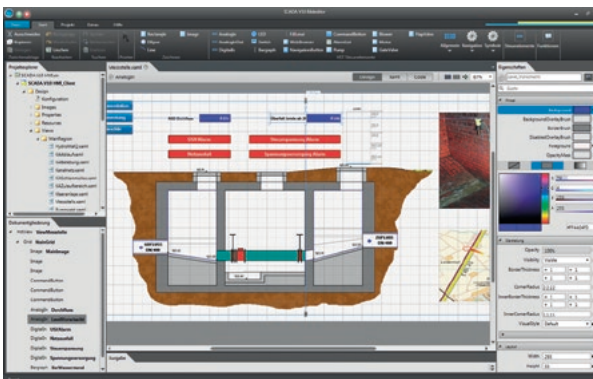
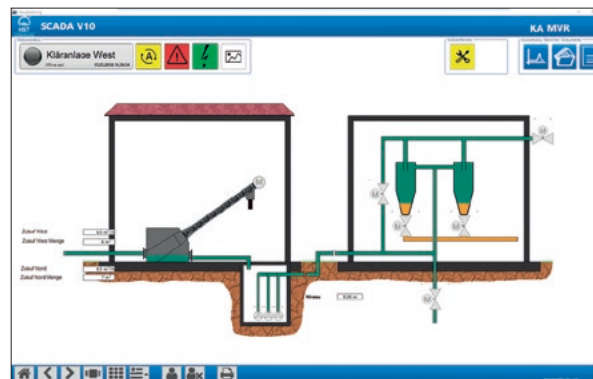
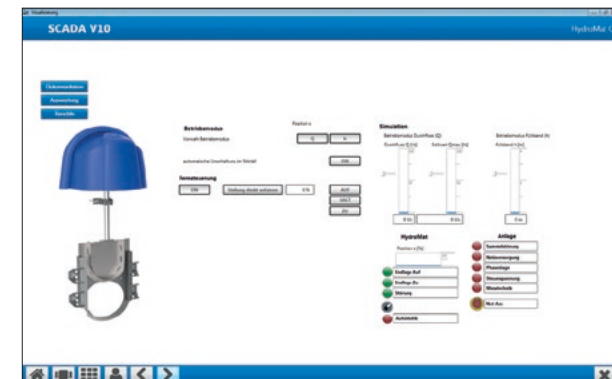

Image editor



Sewage treatment plant process image



HydroMat E process image

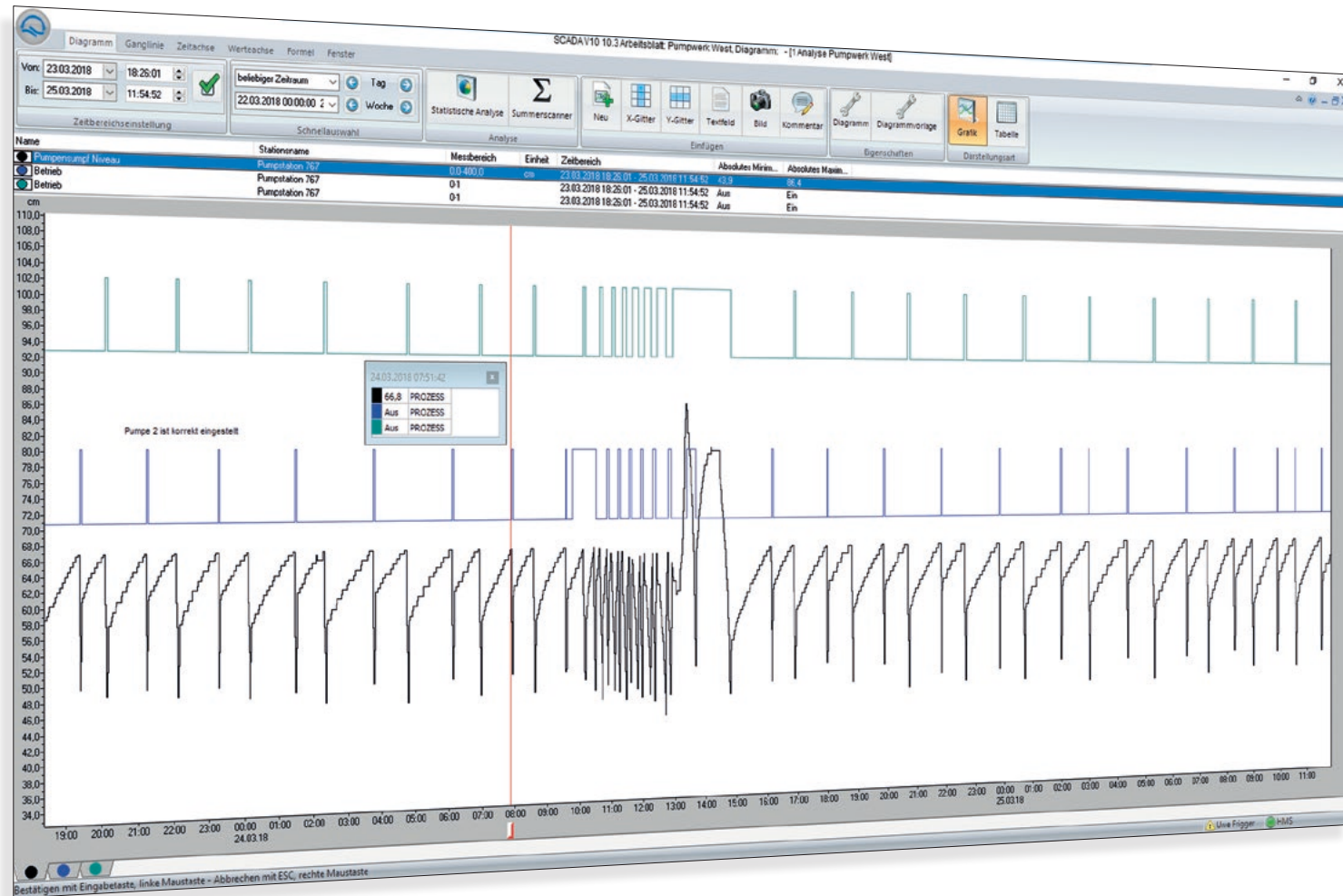

SCADA V10 Analysing and optimising

PRODUCT DESCRIPTION

The display of processes in the form of hydrographs is ideal for analysis. A glance at the hydrograph chart is often enough to be able to make an initial assessment. But it is often also necessary to blend various process data in order to be able to evaluate them relative to each other. For this purpose, SCADA V10 offers a high-functioning graphical evaluation capability.

Particularly with an analysis tool with an extensive functional scope, it is especially important for the user interface to be designed ergonomically. Important and frequently used functions can be accessed quickly and easily. There are no limits to the graphical evaluation.

All time periods are freely adjustable, and any number of hydrographs can be inserted in any number of diagram windows. With a click of the mouse, the sum scanner determines the operating runtimes of units or the flow quantities in the time range shown. A click on the mouse can also store all displayed process data in CSV format and make it available to other applications. Comprehensive, simple, efficient – graphical evaluation in SCADA V10.

YOUR BENEFITS

- Freely selectable time periods
- Unlimited number of hydrographs
- and diagrams
- Sum scanner for calculating
- flow quantities
- Calculation of operating runtimes
- and switching cycles
- Integrated formula editor
- Precipitation total lines
- Direct spreadsheet export
- Hydrographs freely configurable
- in display and function

APPLICATIONS

- Process optimisation
- Diagnosis of incidents
- General reporting
- Evidence of self-monitoring

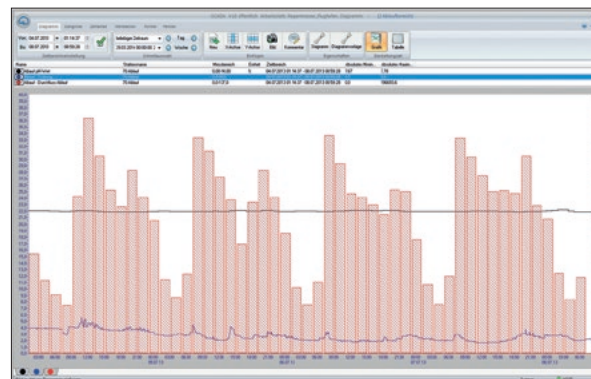

Presentation of hydrographs as column diagram

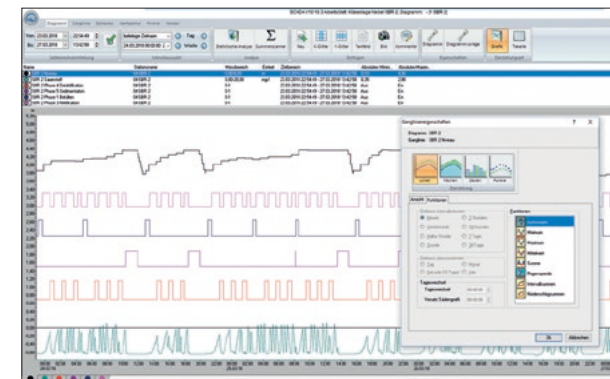

Selection of hydrograph function

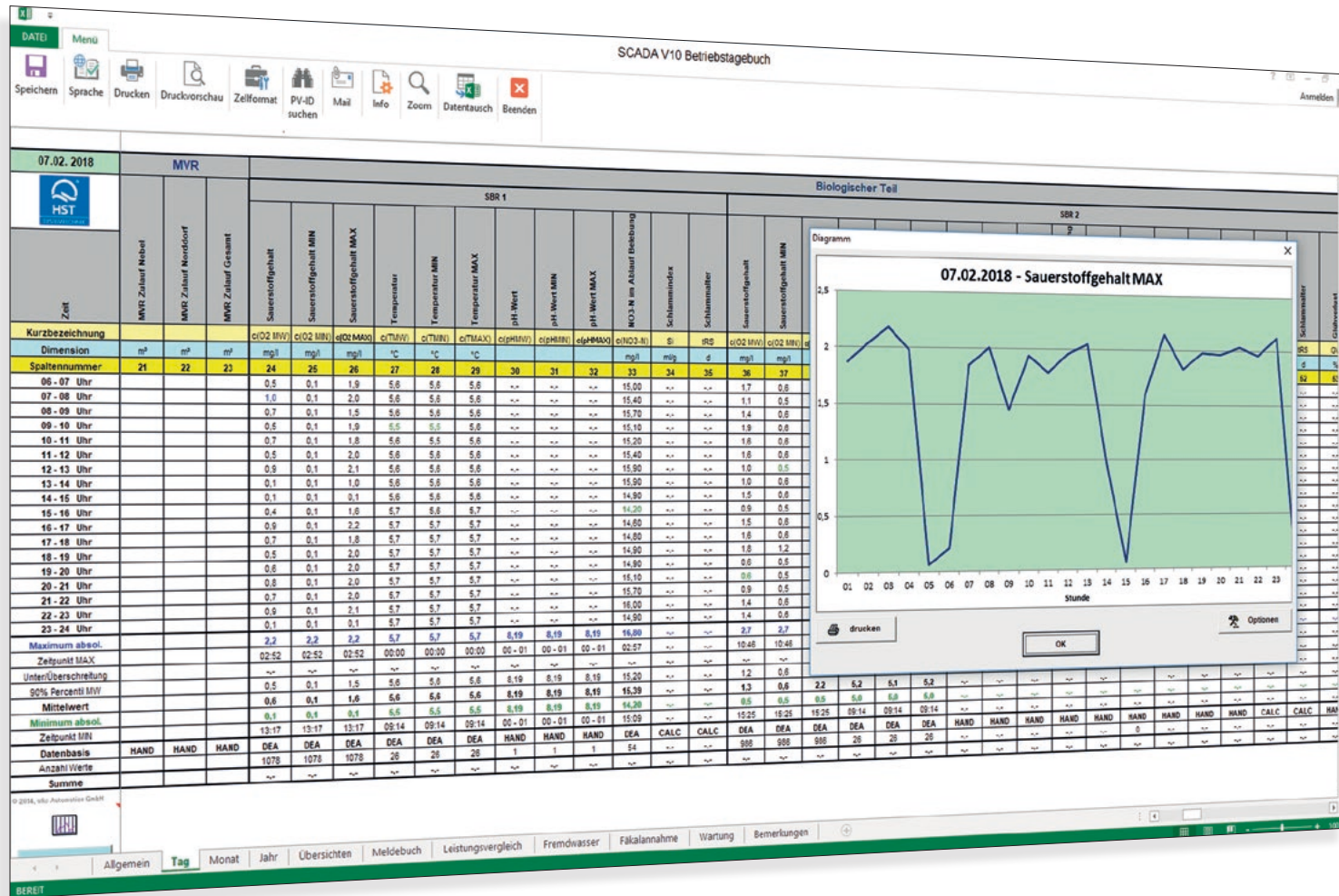

SCADA V10 Reports and protocols

PRODUCT DESCRIPTION

Alongside the graphical analysis of the processes, all process data can also be prepared in the form of reports and protocols. To log the sewage treatment plant process, you can select an operating log in accordance with the DWA-M260, Hirthammer or Kollotzek operating log. Furthermore, there are also protocol libraries for water supply, energy supply and flood protection available. The integrated interface to Microsoft Excel enables the designing of project-specific protocols. Using this, it is possible to access the system configuration and the archive system directly and interactively from Excel.

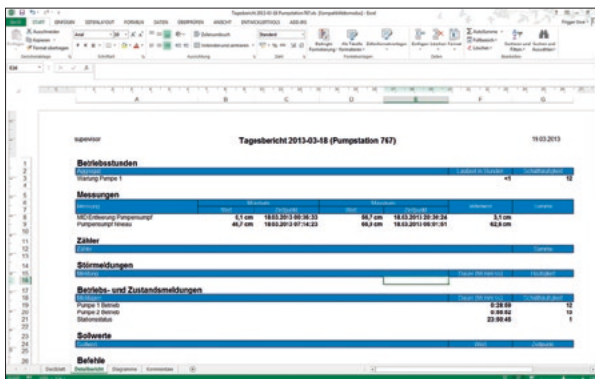

Daily report special structure

YOUR BENEFITS

- Free selection of the operating log
- Comprehensive report library
- Customisable reports in Microsoft Excel
- Reporting for servicing
- and error analysis
- Directly integrated into Microsoft Excel

APPLICATIONS

- Operating logs for sewage treatment plants
- Zone protocols for water supply
- Servicing and analysis of weak points
- Special structures in the sewage network

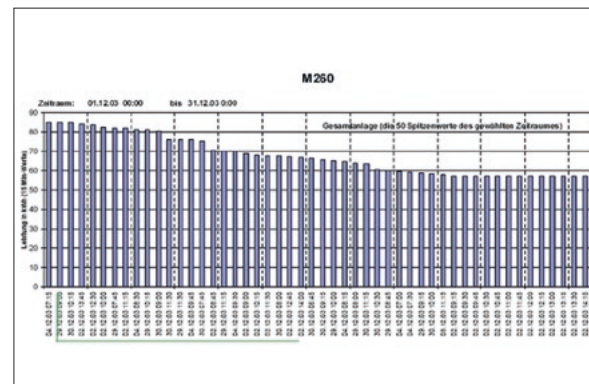

M260 – Evaluation of maximum consumption

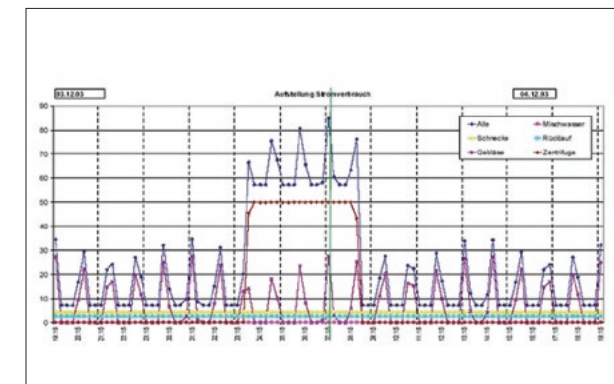

M260 – Distribution of electricity consumption

03.04.2018 Ereignisbericht RÜB West
Ereignisprotokoll
 Tagesbericht vom 03.04.2018
 RÜB West

Bauwerksdaten

Einstau
 Erfassung über x Mischung o Meldung
 Signal RÜB Niveau
 Einstauhöhe: 0,5 m
 Hysterese: 60 Sek.

Beckenüberlauf
 Erfassung über x Füllstand o Durchflussmessung
 Signal RÜB Niveau
 Schwellenhöhe: 1,54 m
 Hysterese: 60 Sek.
 Schwellenlänge: 5,5 m
 Überfallvorwärt: 0,65

Zusammenfassung

Einstauereignisse	Anzahl	2 n	
	Dauer	02:11 hh:mm	
	max. Einstauniveau	1,60 m	
	max. Einstauvolumen	117 m³	
	max. Füllgrad	-- %	
Entlastungsereignisse	KU	Anzahl	1 n
		Dauer	00:04 hh:mm
		Menge	28 m³
	BU	Anzahl	-- n
		Dauer	-- hh:mm
		Menge	-- m³
	gesamt	Anzahl	1 n
Dauer	00:04 hh:mm		
Menge	28 m³		
Auswertung Aggregate (im Berichtszeitraum)	--	Betriebsstunden	-- hh:mm
		Schaltspiele	-- n
		Energieverbrauch	-- kWh
	--	Betriebsstunden	-- hh:mm
		Schaltspiele	-- n
		Energieverbrauch	-- kWh
Ablauf zur Kläranlage	Menge im Berichtszeitraum	m³	
Ablauf zur Kläranlage	Menge während Einstau	m³	

SCADA V10 Tagesbericht vom 03.04.2018 1 von 4

Beginn [TT.MM.YYYY hh:mm]	Ende [TT.MM.YYYY hh:mm]	Dauer [n T hh:mm]
01.01.2007 01:43	01.01.2007 09:11	07:28
01.01.2007 02:49	01.01.2007 04:45	01:56
01.01.2007 06:50	01.01.2007 08:21	02:31
gesamt BU		04:57
01.01.2007 11:40	01.01.2007 13:52	02:12
01.01.2007 12:16	01.01.2007 12:17	00:01
gesamt BU		00:01
04.01.2007 16:17	04.01.2007 17:03	00:46
06.01.2007 18:29	06.01.2007 20:16	01:48
07.01.2007 01:42	07.01.2007 05:14	03:32
07.01.2007 02:05	07.01.2007 04:07	02:02
gesamt BU		02:02
08.01.2007 23:10	09.01.2007 00:07	00:57
10.01.2007 21:53	10.01.2007 21:43	00:40
11.01.2007 21:06	11.01.2007 23:57	02:50
11.01.2007 21:25	11.01.2007 23:02	01:37
gesamt BU		01:37
16.01.2007 11:11	16.01.2007 12:13	01:02
19.01.2007 06:44	19.01.2007 09:31	02:46
19.01.2007 07:10	19.01.2007 08:15	01:05
gesamt BU		01:05
20.01.2007 19:23	20.01.2007 22:04	02:41
20.01.2007 19:46	20.01.2007 21:11	01:25
gesamt BU		01:25
08.02.2007 13:45	08.02.2007 18:26	04:41
08.02.2007 14:13	08.02.2007 17:33	03:20
gesamt BU		03:20
11.02.2007 16:39	11.02.2007 15:17	04:38
11.02.2007 11:04	11.02.2007 14:23	03:19
gesamt BU		03:19
11.02.2007 15:47	11.02.2007 18:48	03:02
11.02.2007 16:05	11.02.2007 17:55	01:51
gesamt BU		01:51
12.02.2007 09:37	12.02.2007 13:56	04:21
12.02.2007 11:30	12.02.2007 13:04	01:32
gesamt BU		01:32
12.02.2007 16:10	12.02.2007 19:01	03:50
12.02.2007 15:32	12.02.2007 16:51	01:18
12.02.2007 17:15	12.02.2007 18:08	00:53
gesamt BU		02:11
13.02.2007 03:08	13.02.2007 04:24	01:16
14.02.2007 21:46	14.02.2007 23:49	02:03

Monatsbericht Januar 2018 2 von 4

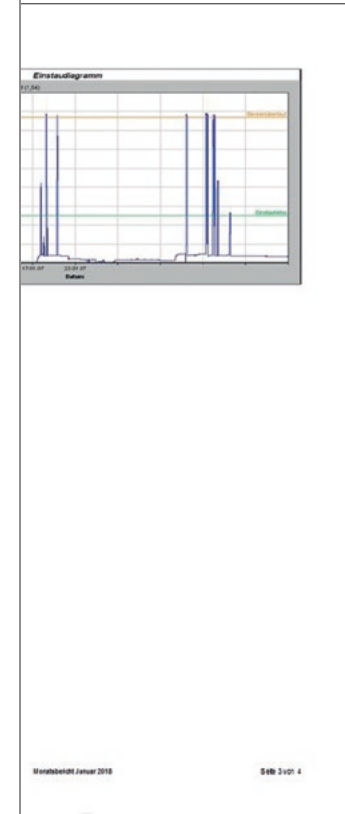

SCADA V10 Event logging for rainwater reservoirs

PRODUCT DESCRIPTION

There are more than 50,000 rainwater reservoirs and sewerage overflows installed in Germany. The overflow amounts must be recorded and documented as part of self-inspection for water pollution control. HST has developed a specialised protocol for the logging of flooding and overflow events for rainwater reservoirs. The logging system for rainwater reservoirs can be freely configured by the user. Calculation of the overflow amounts is performed fundamentally on the basis of the raw data recorded.

YOUR BENEFITS

- Freely configurable sensors and
- tank geometry
- Calculation based on the raw data
- Output as tables and graphs
- Free input of the reporting period
- Directly integrated into Microsoft Excel

APPLICATIONS

- Documentation of the overflow events
- Demonstration of performance
- Report for self-monitoring



More information about SensoMatic EMA
on page 111

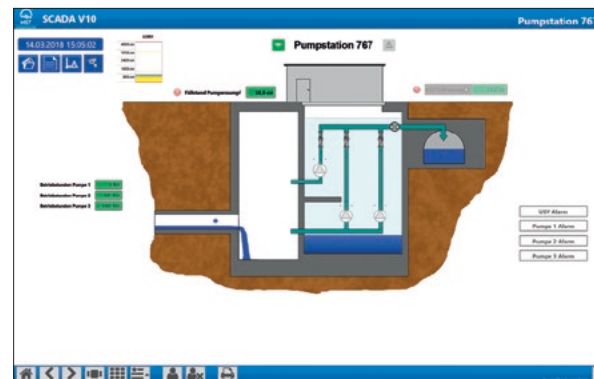

Graphical attachment to the event log

Mittlere Niederschläge 2018 SCADA V10
 [Niederschlagshöhe in mm]

Jahressumme: 471,6 mm

Jan	Feb	Mrz	Apr	Mai	Jun	Jul	Aug	Sep	Okt	Nov	Dez
Di 1. 0,0	Fr 1. 10,7	Sa 1. 10,2	Di 1. 0,0	Do 1.	So 1.	Di 1.	Fr 1. 0,0	Mo 1. 3,7	Mi 1. 5,8	Sa 1. 0,0	Mo 1. 0,0
Mi 2. 0,0	Sa 2. 0,2	So 2. 0,1	Mi 2. 1,1	Fr 2.	Mo 2. 6,5	Mi 2.	Sa 2.	Di 2.	Do 2. 3,7	So 2.	Di 2. 4,9
Do 3.	So 3.	Mo 3. 1,1	Do 3. 0,9	Sa 3.	Di 3. 3,6	Do 3. 1,1	So 3. 1,6	Mi 3. 8,3	Fr 3. 0,1	Mo 3.	Mi 3. 13,4
Fr 4. 0,3	Mo 4. 0,9	Di 4. 0,5	Fr 4. 2,1	So 4.	Mi 4. 4,9	Fr 4.	Mo 4. 7,0	Do 4. 0,9	Sa 4. 0,9	Di 4. 0,0	Do 4. 5,2
Sa 5. 8,3	Di 5. 3,3	Mi 5. 0,0	Sa 5. 7,8	Mo 5.	Do 5. 1,8	Sa 5.	Di 5.	Fr 5. 0,3	So 5. 1,4	Mi 5.	Fr 5. 3,8
So 6. 3,3	Mi 6. 2,9	Do 6.	So 6. 2,1	Di 6.	Fr 6.	So 6. 0,4	Mi 6.	Sa 6. 4,1	Mo 6. 13,4	Do 6. 0,0	Sa 6. 0,8
Mo 7. 3,7	Do 7. 0,0	Fr 7. 0,0	Mo 7. 9,7	Mi 7.	Sa 7. 0,1	Mo 7. 4,1	Do 7. 5,5	So 7. 0,1	Di 7. 0,3	Fr 7.	So 7. 0,3
Di 8. 1,3	Fr 8.	Sa 8. 0,2	Di 8. 0,0	Do 8.	So 8. 1,6	Di 8. 1,1	Fr 8. 13,9	Mo 8. 2,6	Mi 8. 0,2	Sa 8. 0,1	Mo 8.
Mi 9. 1,0	Sa 9.	So 9.	Mi 9.	Fr 9.	Mo 9. 0,0	Mi 9.	Sa 9. 0,1	Di 9.	Do 9.	So 9. 1,5	Di 9. 0,0
Do 10. 0,0	So 10.	Mo 10. 0,9	Do 10.	Di 10.	So 10.	Do 10.	So 10. 0,3	Mi 10.	Fr 10.	Mo 10. 0,2	Mi 10. 0,1
Fr 11. 0,0	Mo 11.	Di 11. 4,8	Fr 11.	So 11.	Mi 11.	Fr 11. 8,1	Mo 11. 1,1	Do 11.	Sa 11. 0,0	Di 11. 0,0	Do 11. 0,0
Sa 12.	Di 12.	Mi 12. 9,2	Sa 12.	Mo 12.	Do 12. 4,6	Sa 12. 0,1	Di 12. 6,9	Fr 12. 6,4	So 12. 0,1	Mi 12. 0,3	Fr 12.
So 13. 0,0	Mi 13.	Do 13. 0,3	So 13.	Di 13.	Fr 13. 1,3	So 13.	Mi 13. 2,7	Sa 13. 7,8	Mo 13. 0,1	Do 13. 0,0	Sa 13.
Mo 14. 0,0	Do 14.	Fr 14. 12,0	Mo 14.	Mi 14.	Sa 14. 0,1	Mo 14.	Do 14. 0,0	So 14.	Di 14.	Fr 14.	So 14.
Di 15. 0,0	Fr 15.	Sa 15.	Di 15.	Mo 15.	So 15. 2,5	Di 15.	Fr 15. 2,1	Mo 15. 0,0	Mi 15. 0,6	Sa 15.	Mo 15.
Mi 16. 2,2	Sa 16.	So 16. 4,4	Mi 16.	Fr 16.	Mo 16. 0,1	Mi 16. 0,4	Sa 16.	Di 16.	Do 16. 8,3	So 16. 1,4	Di 16.
Do 17. 6,9	So 17.	Mo 17. 1,9	Do 17.	Sa 17.	Di 17.	Do 17. 0,5	So 17.	Mi 17.	Fr 17. 0,0	Mo 17. 0,0	Mi 17. 0,4
Fr 18. 1,2	Mo 18.	Di 18. 0,0	Fr 18.	So 18.	Mi 18.	Fr 18. 0,3	Mo 18.	Do 18.	Sa 18.	Di 18. 0,0	Do 18. 0,0
Sa 19. 0,3	Di 19.	Mi 19. 0,2	Sa 19.	Mo 19.	Do 19.	Sa 19. 5,9	Di 19. 9,1	Fr 19.	So 19.	Mi 19.	Fr 19. 0,8
So 20.	Mi 20. 1,7	Do 20. 4,6	So 20.	Di 20.	Fr 20. 2,1	So 20. 0,5	Mi 20. 1,5	Sa 20.	Mo 20.	Do 20. 2,0	Sa 20. 7,2
Mo 21. 0,5	Do 21. 1,2	Fr 21. 12,3	Mo 21.	Mi 21.	Sa 21.	Mo 21. 0,8	Do 21. 0,0	So 21. 1,6	Di 21. 1,8	Fr 21. 4,7	So 21. 0,6
Di 22. 2,2	Fr 22. 0,2	Sa 22. 3,9	Di 22.	Do 22.	So 22. 0,1	Di 22. 1,1	Fr 22. 13,3	Mo 22. 0,5	Mi 22. 4,0	Sa 22. 1,2	Mo 22. 0,1
Mi 23.	Sa 23.	So 23. 0,0	Mi 23.	Fr 23.	Mo 23. 0,0	Mi 23.	Sa 23. 2,2	Di 23. 1,2	Do 23.	So 23. 2,8	Di 23.
Do 24. 0,0	So 24.	Mo 24. 1,5	Do 24.	Sa 24.	Di 24. 0,0	Do 24.	So 24.	Mi 24. 0,2	Fr 24.	Mo 24. 3,6	Mi 24. 0,0
Fr 25.	Mo 25. 0,5	Di 25. 1,2	Fr 25.	So 25.	Mi 25. 10,4	Fr 25. 0,0	Mo 25. 0,1	Do 25.	Sa 25.	Di 25. 0,3	Do 25.
Sa 26.	Di 26. 4,2	Mi 26. 1,5	Sa 26.	Mo 26.	Do 26.	Sa 26. 2,1	Di 26.	Fr 26.	So 26.	Mi 26.	Fr 26.
So 27.	Mi 27. 0,0	Do 27. 0,0	So 27.	Di 27.	Fr 27.	So 27. 0,4	Mi 27.	Sa 27.	Mo 27. 13,9	Do 27. 0,0	Sa 27.
Mo 28.	Do 28. 2,8	Fr 28. 2,5	Mo 28.	Mi 28.	Sa 28. 0,0	Mo 28.	Do 28.	So 28.	Di 28. 3,1	Fr 28.	So 28.
Di 29.	Fr 29.	Sa 29. 0,5	Di 29.	Do 29.	So 29.	Di 29. 0,0	Fr 29.	Mo 29. 0,1	Mi 29. 0,8	Sa 29.	Mo 29.
Mi 30. 1,7	So 30.	Mi 30.	Fr 30.	Mo 30.	Di 30. 3,6	Mi 30.	Sa 30.	Do 30. 11,9	Fr 30. 1,5	So 30. 0,0	Di 30.
Do 31. 0,0	Mo 31.	Sa 31.	Di 31.	Fr 31.	Mo 31. 5,5	Do 31. 5,5	So 31.	Fr 31. 1,5	Mo 31. 18,2	Di 31. 37,5	
33,0	28,6	73,8	23,7	0,0	39,8	36,0	67,4	49,6	64,2	18,2	37,5

SCADA V10 Logging of precipitation

PRODUCT DESCRIPTION

The evaluation of precipitation is an important basis for all water management planning, sewage network sizing, flood warnings, agriculture, forestry and tourism. An important pre-requisite for high quality evaluation of precipitation events is a suitable procedure for the recording of precipitation data. SCADA V10 saves the precipitation data using a specialised procedure to ensure that there is a secured database for the assessment of the situation data here

SCADA V10 provides comprehensive reporting for the documentation and evaluation of precipitation. Alongside the graphical representation in the form of precipitation cumulative frequency polygons, there are also annual, monthly and daily reports available as well as event reports that carry out the classification of precipitation events on the basis of regional KOSTRA tables.

YOUR BENEFITS

- Classification of precipitation events
- Direct connection to the NiRA.web precipitation portal
- Evaluation via precipitation cumulative frequency polygons
- Pre-generated precipitation reporting
- Customisable reports via Microsoft Excel
- Directly integrated into Microsoft Excel

APPLICATIONS

- Proof in the event of damages
- Reports for self-monitoring
- Fundamentals for planning
- Documentation of events

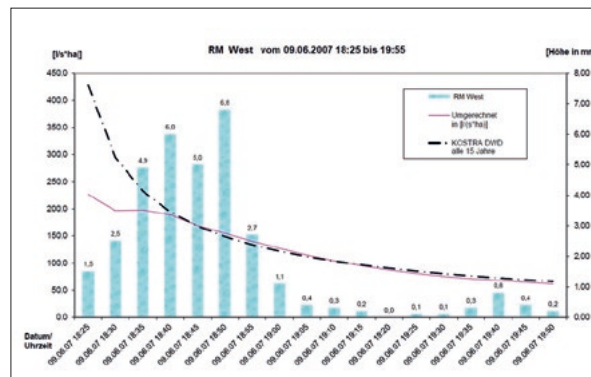

Assessment of precipitation

Niederschlag in [mm]		Sortiert vom größten zum nächst größten nachfolgenden Zielwert		Aufsummiert		Umgerechnet in [l/s*ha]
Datum/Uhrzeit	mm	Minuten	Datum/Uhrzeit	mm	mm	l/s
09.06.07 18:25	1,50	5	09.06.07 18:50	6,80	6,80	226,6
09.06.07 18:30	2,50	10	09.06.07 18:45	5,00	11,80	197,6
09.06.07 18:35	4,90	15	09.06.07 18:40	6,00	17,80	197,7
09.06.07 18:40	5,00	20	09.06.07 18:35	4,90	22,70	199,1
09.06.07 18:45	5,00	25	09.06.07 18:55	2,70	25,40	197,3
09.06.07 18:50	6,80	30	09.06.07 18:30	2,50	27,90	194,0
09.06.07 18:55	2,70	35	09.06.07 19:25	1,50	29,40	196,0
09.06.07 19:00	1,10	40	09.06.07 19:20	1,10	30,50	199,0
09.06.07 19:05	0,40	45	09.06.07 19:05	0,40	30,90	194,4
09.06.07 19:10	0,30	50	09.06.07 19:10	0,30	31,20	197,5
09.06.07 19:15	0,20	55	09.06.07 19:15	0,20	31,40	196,1
09.06.07 19:20	0,00	60	09.06.07 19:20	0,00	31,40	197,2
09.06.07 19:25	0,10	65	09.06.07 19:25	0,10	31,50	197,2
09.06.07 19:30	0,10	70	09.06.07 19:30	0,10	31,60	197,2
09.06.07 19:35	0,30	75	09.06.07 19:35	0,30	31,90	197,9
09.06.07 19:40	0,80	80	09.06.07 19:40	0,80	32,70	199,1
09.06.07 19:45	0,40	85	09.06.07 19:45	0,40	33,10	194,9
09.06.07 19:50	0,20	90	09.06.07 19:50	0,20	33,30	195,5

Niederschlagslinien und Niederschlagspenden in Abhängigkeit von der Niederschlagsdauer und der Ereignishäufigkeit
Nach KOSTRA-DWD 2000 Stadtgebiet Frankfurt am Main Mittel-Werra KOSTRA-Rasterhöhen Zellen 96-07, Spalten 23-25

1 jähriges Ereignis	5 jähriges Ereignis	30 jähriges Ereignis
2 jähriges Ereignis	10 jähriges Ereignis	50 jähriges Ereignis
3 jähriges Ereignis	15 jähriges Ereignis	70 jähriges Ereignis
4 jähriges Ereignis	20 jähriges Ereignis	100 jähriges Ereignis

Rainfall intensity lines

SCADA V10 Alarm management

PRODUCT DESCRIPTION

The alarm management and the optimal support of the on-call services that comes along with it is a considerable component of the SCADA system. For this reason, alarm management is also contained completely in SCADA V10 and is not connected via an interface as a third-party product. The benefits are clear: Double parametrisation does not occur as all data are retained in the SCADA V10 database system. User guidance is the same all over the system.

The free configuration of alarm management enables the implementation of a number of alarm concepts, for example, the adjustable escalation scenarios. The on-call services are informed via a variety of different services such as SMS, e-mail, voice messages or Telegram messenger and can intervene directly via their emergency notebook computer, a tablet or their smartphone. The SCADA V10 alarm manager uses all current ALL IP telephone connections and is therefore equipped for the changeover to the Telekom digital communications network.

YOUR BENEFITS

- Completely integrated into the SCADA system
- Free configuration of scenarios
- Freely configurable templates for daily, weekly and monthly plans
- Alarms via SMS, e-mail and Telegram messenger
- Fully synthetic voice message
- Freely configurable emergency plans
- App for iPhone or Android

APPLICATIONS

- Communication of critical errors
- Supporting the on-call services

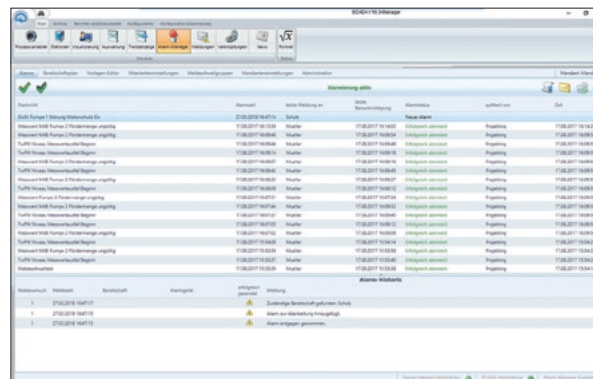

Configuration of employees



Acknowledging with the SCADA app

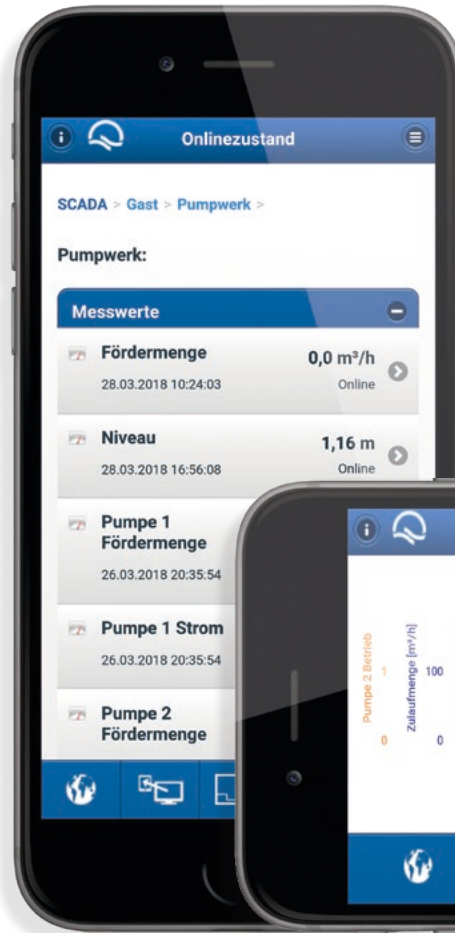
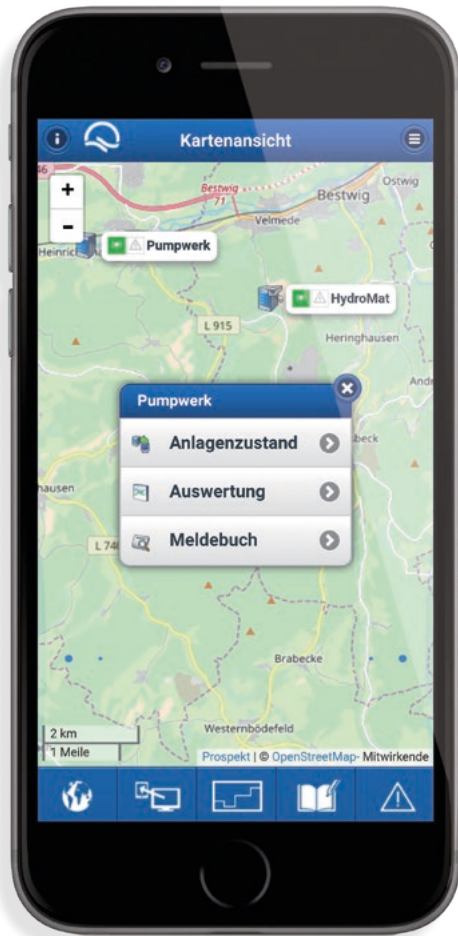

SCADA V10 Smart mobility

The app for SCADA systems

It is important to be informed quickly about any errors in order that you are then able to react immediately, in particular for the on-call services. SCADA systems from HST provide a variety of solutions for external access. Alongside the direct access via the classic user workplace, the SCADA system can be operated directly via an internet browser or via an app that has been especially designed for smartphones and tablet computers. The SCADA system can therefore be operated from any location at any time. Only an internet connection is required to use it. For security reasons, data transmission is performed completely encrypted via the internet.

The mobile SCADA solution covers all of the important functions of the SCADA system. This of course includes graphic visualisation in the form of process images, the presentation of hydrographs and the display of error messages and their acknowledgement. Furthermore, one can also intervene directly into the process via remote access, whereby appropriate user rights are required for this purpose. Using the SCADA app, the on-call services can be informed quickly and conveniently about the plant status and can therefore react in a targeted manner at any time.

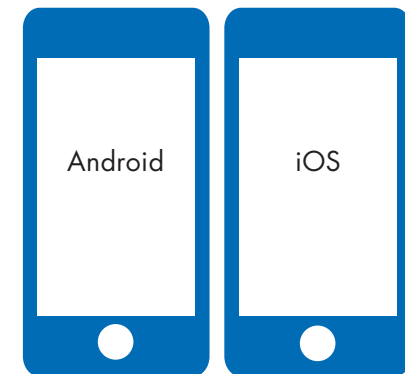

Security at a glance

The water management interconnected control system for the large district town of Öhringen

Water supply, sewage treatment and flood protection in just one control system: HST achieved this in the large district town of Öhringen which started experiencing problems with its process control system around the turn of the millennium. The system that dated from 1993 was not able to document after 01/01/2000, the turn of the millennium. Updating the software was too expensive, procurement of replacement parts was possible only for a short time. It was feared that the functionality of the entire waterworks could be endangered if this was not dealt with.

In addition to this, there were problems with the remote control technology for the sewage treatment plant. When an attempt was made to connect additional rainfall overflow basins to the remote control system for the sewage treatment plant, the system crashed completely. There followed a thorough inventory of the water supply and the sewage sector. During this process, it quickly became clear that a major solution for the process control technology of both sectors, and also for flood protection, was desirable. During this period, the operators visited several communities in order to get to know the range of services of different control systems.

In the end, the decision was made for Öhringen, because the amortisation calculation for the water management interconnected control system was extremely positive. So for example, due to the intended installation of measurement devices in the water supply network, it was expected that the amount of pipeline losses could be reduced to a minimum of eight percent, or even to four percent; the average of pipeline losses from the period from 1993 to 2004 was 13.7 percent.

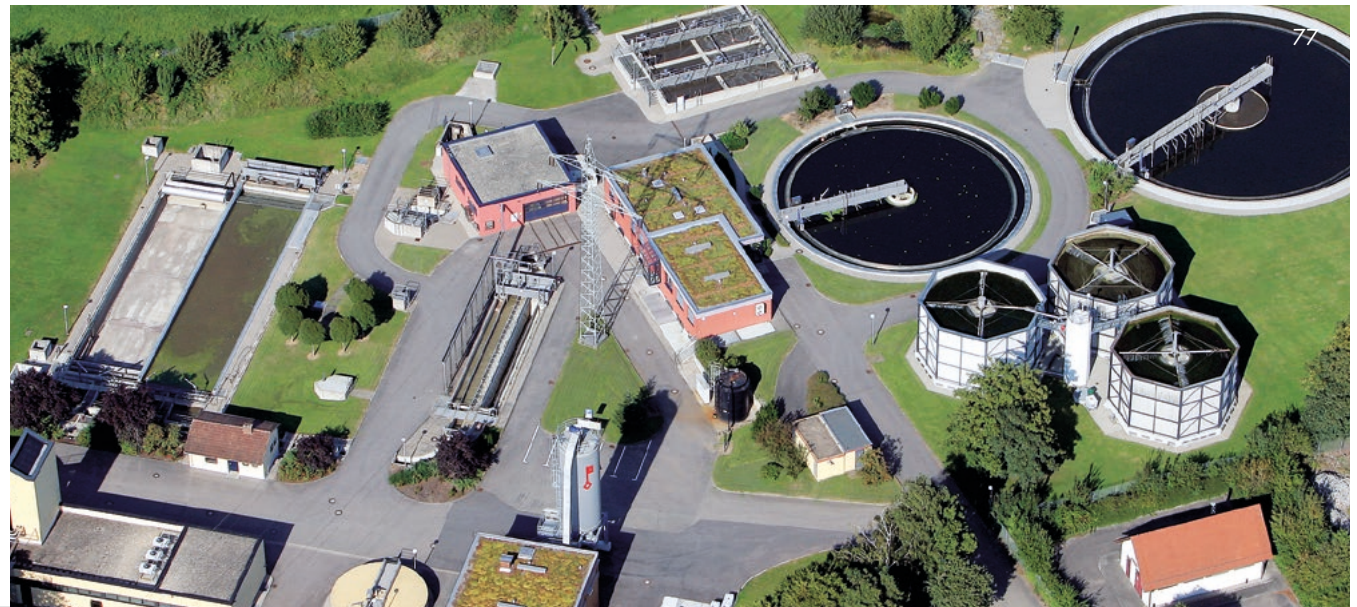

Savings effects were also calculated in the area of monitoring for the operating costs for sewage water management. Regular inspections are in the end a legal obligation. As a result, neglecting these inspections would have criminal consequences. If, according to the calculation, a change is made from manual monitoring to the process control technology, then inspection will take place automatically in the future and this is therefore better. And so much is clear: All of these expected events occurred.

The changeover to the interconnected control system took place from 2006 to 2010 and the update to the latest version, SCADA V10 took place in 2017. The focus was placed on the security of the system. HST works with redundant systems that synchronise data and reports both at the local level (in the individual plants) and also at the higher levels (between the individual plants).

Thanks to the interconnected control system, the operators are now in the convenient position of having an overview of the whole system. Burst pipes can be localised quickly. The system provides an error message immediately for critical conditions. Furthermore, the rainfall overflow basins are controlled and the performance of the sewage treatment plants are monitored by SCADA V10. With regards to flood protection, safety reports can be created and current information about the water levels can be displayed online on the city website.



SCADA.web

Outstanding monitoring of plants on the internet



SCADA.web Unlimited monitoring of plants on the internet

SCADA.web is the portal for remote monitoring for operators of decentralised plants and networks in the water and energy industry. SCADA.web impresses with its simple and intuitive operation and with a complete range of functions. This includes the visualisation and operation of processes via clear process images, the analysis of process data via hydrographs and reports and the complete alarm management system including the remote sending of alarms to the on-call services.

There is a good reason that SCADA.web has received multiple awards.

SCADA.web - The all-round care free package

Investment costs and operating costs are reduced considerably with the option of operating SCADA.web which can be operated in a German computer centre. Purchasing server hardware and the procurement of software licences for operating systems and for the SCADA software itself is not required. Furthermore, the computer centre also assumes ensuring the availability and the IT security and guarantees the data backups required. The investment required is limited to a usage fee, comparable to the fee when signing a mobile phone contract. The automatic provision of all software update is already included in the usage fee.

Alternatively, instead of being used in a computer centre, SCADA.web can of course be used in your company and installed on a server system. In this case, the SCADA.web software is purchased once and the system administration is then in your hands.

SCADA.web – Flexible and open

We are of the opinion that „closed shop solutions“ lead to severe limitations during usage and that they are also not cost effective. SCADA.web supports the current industry standards, for example OPC UA and hence enables connection to remote control systems from different manufacturers. The provision of data from SCADA.web is also performed via standard interfaces.



SCADA.web There is a good reason that it has received multiple awards.

HST SCADA.web

Übersicht | Anlagenzustand | Analyse | Einstellungen | Administratives | Alarm-Manager | Impressum ?

HTML Visualisierung

Sie sind angemeldet als: Supervisor | Ausloggen

Stationenliste

- Kempten
 - Illerdüker_Nord
 - RÜ-106
 - RÜ-121
 - RÜ-122
 - RÜ-124
 - RÜ-128
 - RÜ-131
 - RÜ-132
 - RÜ-133
 - RÜB-206**
 - RW-SK

Anstehende Störungen

18.01.2018 11:04:33
 Illerdüker
 Illerdüker - Stationsstatus GPRS
 Offline

RÜ206 Füssener Straße

Station Online
 RÜB mit Drossel

Kamera
 Auswertung

Rechen
 Automatik
 Rechen läuft nicht
 Grundströmung
 Öldruck 0.50 bar
 Öltemperatur 15.30 °C
 Sicherungsfall Ventile

Not-Entlastungsklappe
 Automatik
 verriegelt

Füllstand 0.54 m

Entlastungshöhe 0.00 m Entlastungsmenge 0.00 m

Illerdüker Nord | RÜ 106 Brachgasse | RÜ 121 Duracher Straße | RÜ 122 Am Heubach | RÜ 124 Hänebergstraße | RÜ 128 Jörgstraße | RÜ 131 Augartenweg Süd | RÜ 132 Augartenweg Nord | RÜ 206 Füssener Straße | RÜ 133 Gärre

SCADA.web Visualisation of processes

SCADA.web contains an interactive map view in which all of the plants being monitored are positioned in their real location, so that you can obtain an overview of your plants quickly and easily. The map view can be zoomed in and moved around, as you are maybe already used to doing with Google Maps. The level of detailing also changes automatically when you change the scale via zooming.

The current plant status is displayed online for all plants using unambiguous symbols. It can thus be shown at a glance whether one of the plants being monitored is being disrupted. Additional information about the corresponding plant can then be obtained via a mouse click directly from the map view mode.

Individual visualisation of the technical plants is performed based on HTML 5 technology.

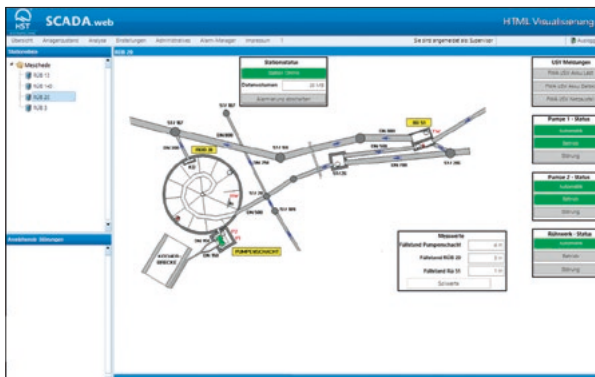

Process screen plan view

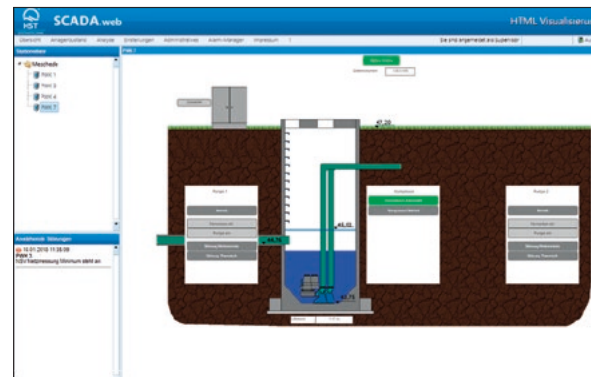

Process screen section display

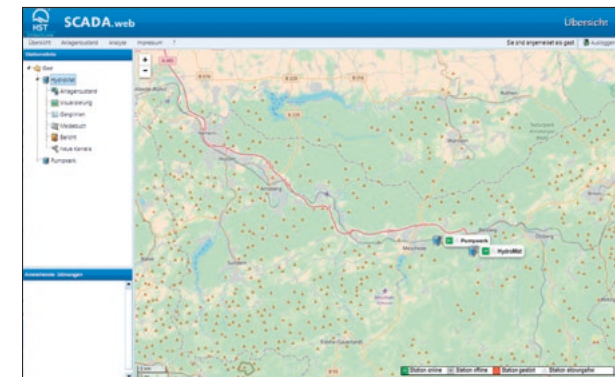

Selection card



SCADA.web Graphical evaluation of process data

PRODUCT DESCRIPTION

SCADA.web is more than visualisation on the internet.

SCADA.web contains graphical analyses for the analysis of your process data. All process data are archived according to the delta event method and can be presented both graphically or in the form of tabular reports for any time periods desired.

The presentation of process values with an accurate time, along with the camera images assigned to the same time provides a special form of analysis. With the help of the ruler, process values and the camera image archived at this time can be displayed simultaneously. Furthermore, there is also a photo gallery for the visual analysis of the plant available.

A special feature is the automatic sending of reports. You will automatically receive finished generated reports in the PDF format via e-mail. Simple and convenient – SCADA.web

YOUR BENEFITS

- Graphical hydrograph analysis
- Temporal analysis of hydrographs and camera images
- Photo gallery for visual analyses
- Integrated reporting
- Event reports for rainwater reservoirs
- Automatic report sending via e-mail
- Storage of evaluation reports

APPLICATIONS

- Process optimisation
- Diagnosis of incidents
- Evidence of self-monitoring

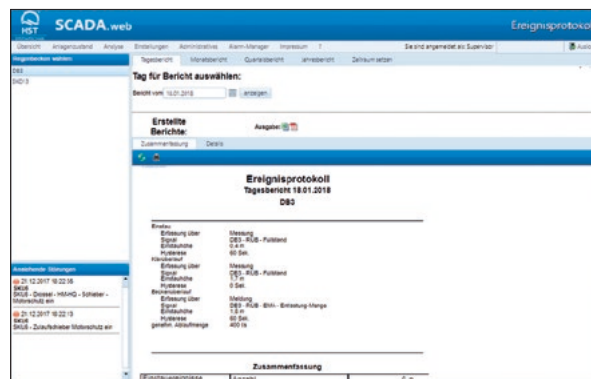

Result log

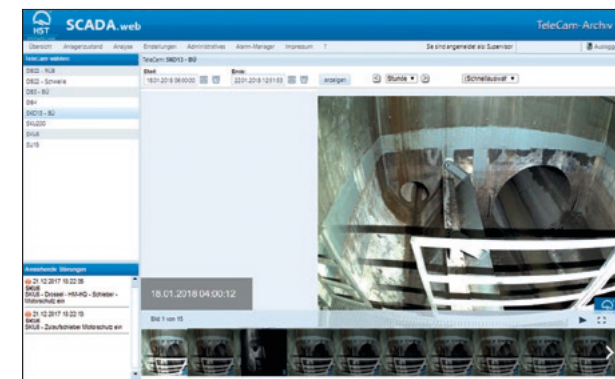

HST TeleCam gallery

The screenshot displays the 'Alarm-Manager' interface within the 'SCADA.web' application. The interface features a navigation menu at the top with options: Übersicht, Anlagenzustand, Analyse, Einstellungen, Administratives, Alarm-Manager, and Impressum. The main area is a calendar grid for the period '01.04.2018 - 30.04.2018'. The calendar has columns for days of the month (01 to 23) and rows for priority levels (1 to 20). A yellow vertical bar highlights the 03rd of April. A red horizontal bar labeled 'Karten' spans from the 03rd to the 08th. A blue horizontal bar labeled 'Lars' spans from the 08th to the 15th. Another blue horizontal bar labeled 'Rajon' spans from the 15th to the 21st. A grey vertical bar is present on the 07th. A small 'Lars' label is also visible at the end of the 23rd column. In the bottom-left corner, there is a section titled 'Anstehende Störungen' (Upcoming Disturbances) which is currently empty.

SCADA.web Alarm management

PRODUCT DESCRIPTION

Alarm messages are sent directly to the on-call services via the integrated alarm management. As a result, the on-call services are informed quickly and securely about critical errors and can react directly. Alarm reporting is performed via e-mail, SMS, voice messages or via the messenger service Telegram. Additionally, all upcoming errors and alarms are displayed directly in the SCADA app.

YOUR BENEFITS

- Completely integrated into the SCADA system
- Freely configurable emergency plans
- Alarm sent via e-mail, SMS, voice message and Messenger
- App for iPhone or Android

APPLICATIONS

- Communication of critical errors
- Supporting the on-call services

The screenshot shows the SCADA.web Alarm Manager interface. At the top, there is a navigation bar with the SCADA.web logo and the title 'Alarm Manager'. Below the navigation bar, there is a search field and a 'Suche eingetragene Alarme' button. The main area displays a table of alarm events. The table has columns for 'Alarm-ID', 'Alarm-Typ', 'Alarm-Text', 'Alarm-Status', 'Alarm-Gruppe', 'Alarm-Gruppe-Icon', 'Alarm-Gruppe-Name', 'Alarm-Gruppe-Icon', 'Alarm-Gruppe-Name', 'Alarm-Gruppe-Icon', 'Alarm-Gruppe-Name'. The table contains several rows of data, including alarm IDs, types, and statuses. Below the table, there is a section for 'Alarm-Details' with a table of columns: 'Alarm-ID', 'Alarm-Typ', 'Alarm-Text', 'Alarm-Status', 'Alarm-Gruppe', 'Alarm-Gruppe-Icon', 'Alarm-Gruppe-Name'. The table contains several rows of data, including alarm IDs, types, and statuses.

Alarm-ID	Alarm-Typ	Alarm-Text	Alarm-Status	Alarm-Gruppe	Alarm-Gruppe-Icon	Alarm-Gruppe-Name
10	Alarm	Alarm-Text	Alarm-Status	Alarm-Gruppe	Alarm-Gruppe-Icon	Alarm-Gruppe-Name
11	Alarm	Alarm-Text	Alarm-Status	Alarm-Gruppe	Alarm-Gruppe-Icon	Alarm-Gruppe-Name
12	Alarm	Alarm-Text	Alarm-Status	Alarm-Gruppe	Alarm-Gruppe-Icon	Alarm-Gruppe-Name
13	Alarm	Alarm-Text	Alarm-Status	Alarm-Gruppe	Alarm-Gruppe-Icon	Alarm-Gruppe-Name
14	Alarm	Alarm-Text	Alarm-Status	Alarm-Gruppe	Alarm-Gruppe-Icon	Alarm-Gruppe-Name
15	Alarm	Alarm-Text	Alarm-Status	Alarm-Gruppe	Alarm-Gruppe-Icon	Alarm-Gruppe-Name
16	Alarm	Alarm-Text	Alarm-Status	Alarm-Gruppe	Alarm-Gruppe-Icon	Alarm-Gruppe-Name
17	Alarm	Alarm-Text	Alarm-Status	Alarm-Gruppe	Alarm-Gruppe-Icon	Alarm-Gruppe-Name
18	Alarm	Alarm-Text	Alarm-Status	Alarm-Gruppe	Alarm-Gruppe-Icon	Alarm-Gruppe-Name
19	Alarm	Alarm-Text	Alarm-Status	Alarm-Gruppe	Alarm-Gruppe-Icon	Alarm-Gruppe-Name
20	Alarm	Alarm-Text	Alarm-Status	Alarm-Gruppe	Alarm-Gruppe-Icon	Alarm-Gruppe-Name

Alarm manager

Smart mobility: The app for SCADA systems

It is important to be informed quickly about any errors in order that you are then able to react immediately, in particular for the on-call services. SCADA.web provides a range of solutions for accessing via mobile devices. On the one hand, access can be performed via a notebook or tablet. The only things needed for this are an internet connection and an internet browser.

There is also the SCADA app available. This app is for the iOS (iPhone/iPad) and Android (smartphones/tablets) platforms. The app provides online access to the process, access to hydrographs and the option of telecontrol. Upcoming alarms are of course also displayed in the app.

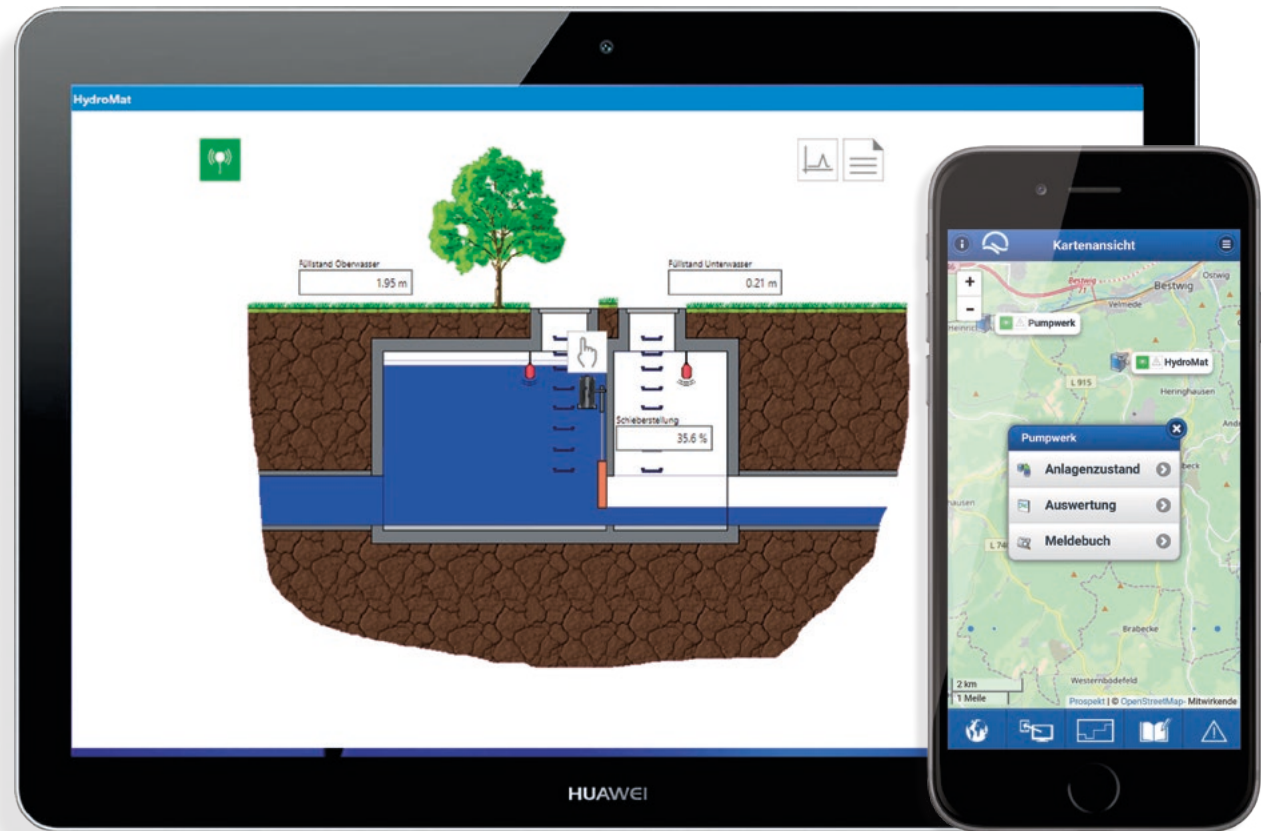

Rent, buy or lease?

Decide for yourself what business model is the best one for you. SCADA.web can be acquired as a classical user licence and can then be installed on your server, or on a computer centre of your choice.

Alternatively, you can use SCADA.web on a monthly user fee basis, comparable to a mobile phone contract with a standard flat rate. With this, you will receive a complete service, including the provision of the necessary hardware infrastructure in a German computer centre and the provision of the software products. Additionally, we will take over the complete system administration and system maintenance, such as ensuring the IT security, automatic data backups and the provision of product updates for you free of charge.

SCADA.web Providing –
Your all-round care free package



**Using the infrastructure
of the system provider**

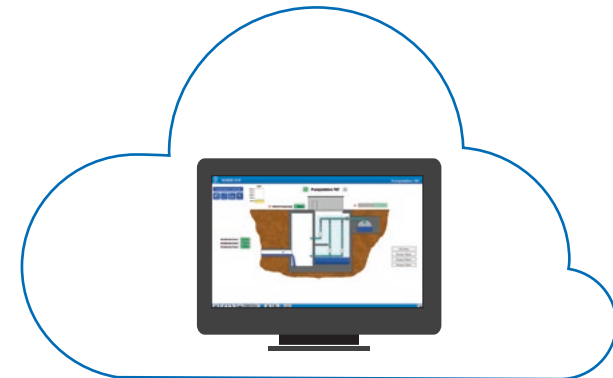

**Using the infrastructure
in a German computer centre**



TeleMatic

Smart collection on site, transmitted securely

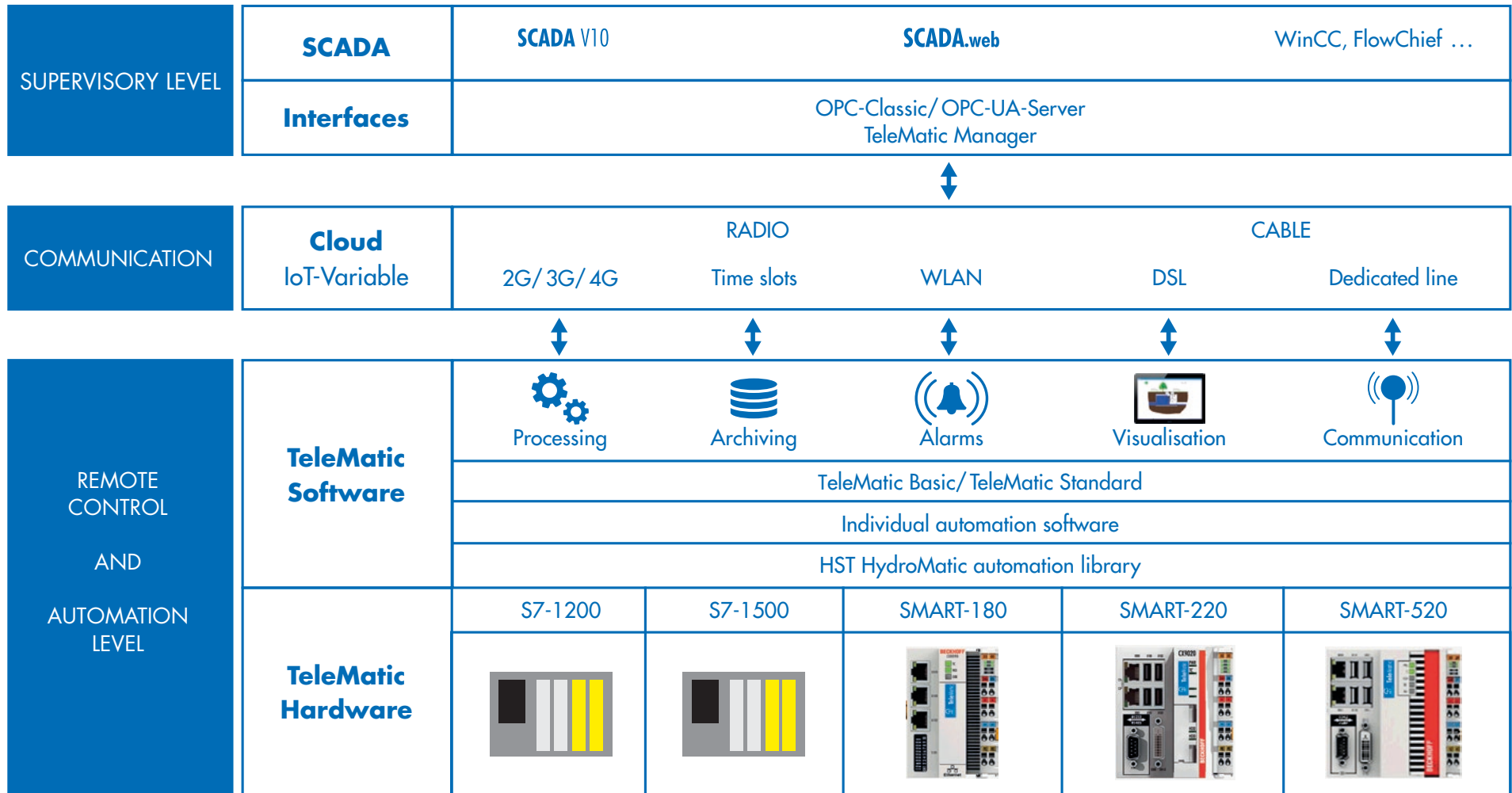

TeleMatic Remote control system

PC-based

The PC-based process monitoring and control system combines innovative telecontrol concepts and proven industry standards with the reliability of the PLC world in one system. Application and industry-specific solutions can be realised easily and securely.

Highlights

The open and highly module TeleMatic system ensures uninterrupted data capture and monitoring of decentralised facilities. The data capture and archiving is performed permanently and event-oriented in accordance with the delta-event standard. At the same time, the automation of machines, processes and plants is possible due to the comprehensive and flexible I/O system and high performance CPU.

Platform neutral

HST TeleMatic software is available for standard hardware components of the manufacturers Beckhoff and Siemens. Choose the hardware platform that is perfectly suited to your solution.



HST TeleMatic SMART-220
(Hardware-Plattform Beckhoff)

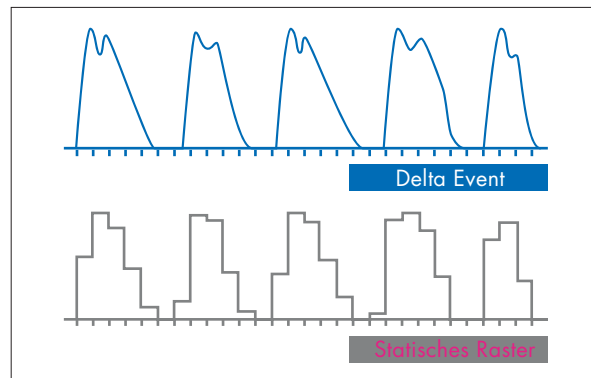

Delta event archiving
compared with grid archiving

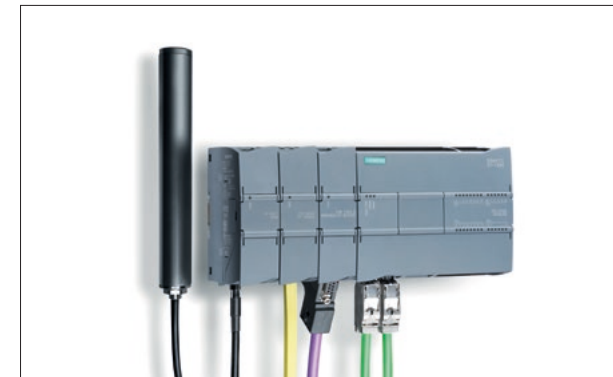

Siemens SIMATIC S7-1200 mit TeleMatic-Software

TeleMatic Interfaces

Communication

HST TeleMatic uses the TCP/IP protocol for transmitting data, the standard protocol for communication in the Internet and intranet. TCP/IP communication is carried out up to the control system. All transmission media that are based on TCP/IP can be used. This provides the maximum level of flexibility when connecting decentralised plants with regards to availability and bandwidth. Using current VPN technologies provides security. At the same time, the communication connection can be used for additional services, for example remote programming or connecting a web-cam for visual monitoring of the plant.

Fieldbus

HST TeleMatic excels due to its high level of flexibility in the connection of existing control technology and fieldbus devices. All commonly used fieldbuses and interfaces such as Profinet, Profibus, Modbus, MPI, RK512, AS511 or ADS can be selected. M-Bus (Metering Bus) enables the acquisition of consumption data for heat, water, electricity and gas meters.

Connection to SCADA systems

The industrial communication standards OPC Classic and OPC UA are used to connect to the higher level SCADA systems. All process data are available with TeleMatic station time stamps that are precise to the second at the OPC server. The time sequence of operating statuses can therefore be traced completely.

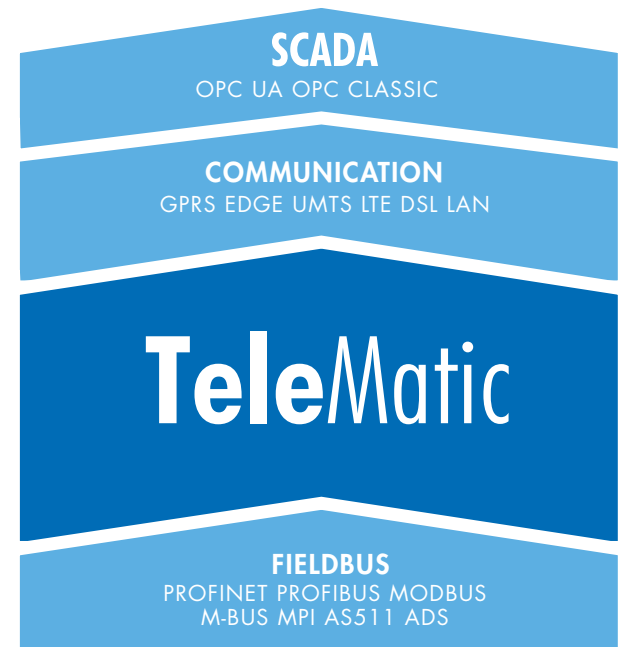

interfaces

TeleMatic Condition Monitoring

PRODUCT DESCRIPTION

HST TeleMatic provides ideal condition monitoring. You will no longer have to worry about the safety, efficiency and availability when your plant and machines are being used. The general status is recorded regularly and monitored. In this way, wear and tear can be recognised early and repaired in a targeted manner. These preventive inspections provide maximum security for your investment and provide optimum servicing.

The 3-phase power measurement module acquires, monitors and records the electrical values of drives. 3-phase mains voltage monitoring has been integrated. The upper and lower limits for the phase currents can be set. In connection with the software, the module monitors the power consumption of power units over adjustable time periods. Altered operating states and operating performance can be recognised from this. Additional measurement values such as overall energy consumption, conductor frequencies, efficiency levels and maximum currents enable additional diagnoses.

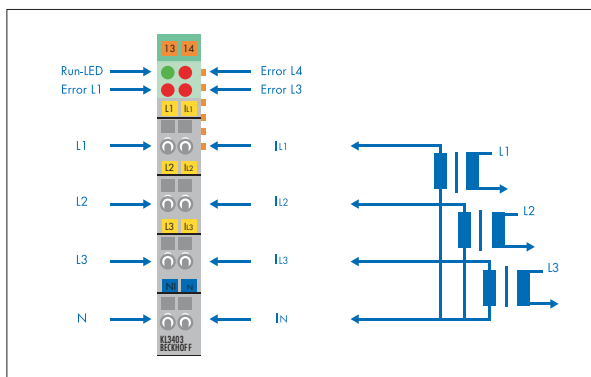

3-phase power measurement module

YOUR BENEFITS

Diagnoses option for a pump:

- Pump clogged
- Rotating in the wrong direction
- Non-return valve closed
- Impeller worn

Diagnosis option for a slide valve:

- Slide valve is stuck
- Slide valve spindle torn off



Condition monitoring for slide valves



TeleMatic for the control system

Smart plant operation on site

Smart operation on site via mobile tablets provides both technical and economic advantages in comparison to permanently installed operating panels at a control cabinet. Despite the high investment costs, a permanently installed operating panel at a control cabinet remains unused for at least 90% of its service life.

A tablet can be used for many different purposes and can take over the function of a permanently installed operating panel in the event that on site operation is required. Convenient and secure plant identification is produced via an operating switch at the control cabinet. By activating the operating switch, the control panel display allocated to the plant will open automatically on the tablet. There is convenient cordless operation present due to an encrypted and switchable WLAN connection between the automation level and the tablet.

The visualisation is provided via the automation device. Cable-less local operation is therefore possible without an internet connection.



YOUR BENEFITS

- Simple operation via mobile tablets
- Operation independent of location
- Lower investment costs
- Added value from mobile tablets due to additional
 - usage options (operations management, documentation)
- Secure operation (selectable WLAN, authentication)

The screenshot shows the TeleMatic.web web interface in a Firefox browser window. The page title is "TeleMatic.web" and the main heading is "Network". The interface includes a left-hand navigation menu with sections for "Online" and "Settings". The main content area displays a network diagram with a computer monitor icon on the left and a server rack icon on the right, connected by a cloud labeled "Online". Below the diagram are two tables: "Server Information" and "IP-Address Information". To the right of the server rack icon is a larger table containing "Hardware Information", "Software Information", and "Additional Information".

Server Information

Server IP:	217.117.96.20
Server Port:	55200

IP-Address Information

Local IP:	192.168.10.90
Public IP:	172.16.19.4

Hardware Information

SMART-Typ:	SMART-220
MAC-Address:	00010515BE33

Software Information

Licence OK:	●
Mapper:	●
GSM Signal:	24
Version TeleMatic Standard:	5.1.1

Additional Information

Version SmartServices:	5.1.0
------------------------	-------

TeleMatic for the control system

TeleMatic Standard

TeleMatic Standard is the software for the acquisition, archiving, transmission and alarm setting of process data. All data will be transmitted and archived in an event-oriented manner according to the delta event method. A volume-optimised protocol on the basis of the TCP/IP protocol leads to a low consumption of data volume and hence to low operating costs, especially in the event of a GPRS communication connection. The usage of standard hardware components provides security for the investment.

Commissioning is performed in a simple and intuitive manner using TeleMatic.web, the TeleMatic Standard web interface. TeleMatic.web is used both for the configuration of the stations and for viewing all configured process data. Therefore, it is also possible to test a data point without having access to the central location.

An archive data storage that is protected against power interruption ensures data security for a period of up to 6 months. Archives are transmitted automatically to the central department in the event of communication being interrupted.

Control functions can be carried out in parallel to the data transmission in accordance with the IEC61131-3 Standard in a separate user program. A Standard interface enables the transmission of data to the TeleMatic Standard software.

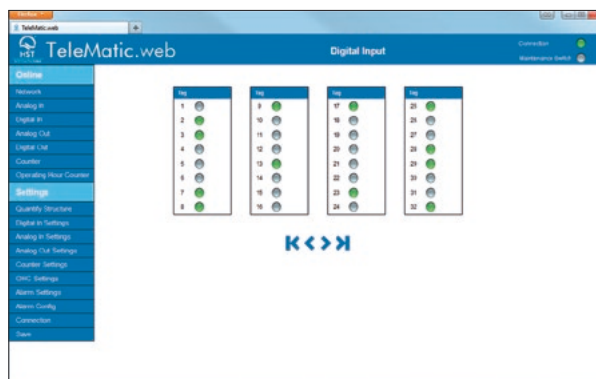

TeleMatic web display of process data

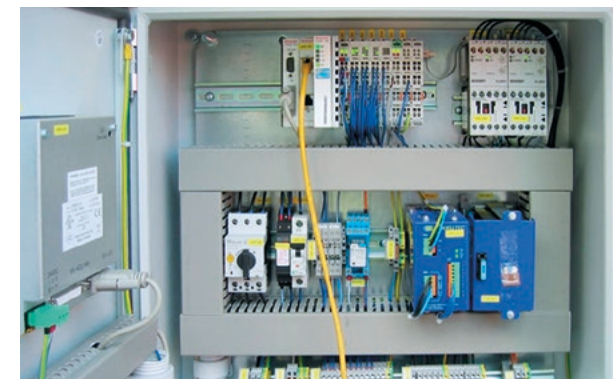

TeleMatic in application

TeleMatic Manager

Online Konfiguration Rangierungen Diagnose Service

Dout AnalogPaFreigabe Acut(R) Wertvorgabe Fernsteuerung

Einstellungsdaten neu Einlesen Neustart SPS Neustart TwinCat Archiv anfordern PA anfordern OPC-Classic-Tag simulieren OPC-UA-Tag simulieren Onlinewerte simulieren

Weitere Funktionen

- [1] PW Schulstraße
- AnalogPaFreigabe
 - Din
 - Dout
 - Ain
 - AinR
 - Acut
 - AcutR
 - Cnt
 - Ohc
 - General
 - Info
- [2] PW Sonnenallee
- [3] PW Waldstraße
- [4] PW Lindenstraße
- [5] PW Amselweg
- [6] PW Goethestraße
- [7] PW Jahnstraße
- [8] PW Feldstraße
- [9] PW Buchenweg
- [10] PW Ringstraße
- [11] PW Mittelweg
- [12] PW Mühlweg
- [13] PW Schützenstraße
- [14] PW Rosenweg
- [15] RUB Bahnhofstraße
- [16] RUB Lindenstraße
- [17] RUB Friedhofstraße
- [18] RUB Meisenweg

Name	Wert	Zeitstempel	OPC-Classic-Tag	OPC-UA-Tag
Name	PW Schulstraße	03.04.2014 17:17:02	TM.OPC_Station[1].Info.Name	TeleMaticManager.Station[1].Info.Name
MAC-Adresse	00010515BE33	03.04.2014 17:17:02	TM.OPC_Station[1].Info.MAC_Adresse	TeleMaticManager.Station[1].Info.StationId
IP-Adresse	80.187.102.129	03.04.2014 17:17:31	TM.OPC_Station[1].Info.IP_Adresse	TeleMaticManager.Station[1].Info.IP_Adresse
TCP-Port	21407	03.04.2014 17:17:31	TM.OPC_Station[1].Info.Port	TeleMaticManager.Station[1].Info.TopPort
Software Version	5.1.1	03.04.2014 17:17:41	TM.OPC_Station[1].Info.PkgVersion	TeleMaticManager.Station[1].Info.PkgVersion
Letzter Empfang	03.04.2014 17:32:43	03.04.2014 17:32:43	TM.OPC_Station[1].Info.Letzter_Empfang	TeleMaticManager.Station[1].Info.LetzterEmpfang
Feldstärke	24	03.04.2014 15:08:02	TM.OPC_Station[1].Info.Feldstaerke	TeleMaticManager.Station[1].Info.Feldstaerke
Station neu gestartet	False	03.04.2014 15:07:19	TM.OPC_Station[1].Info.StationNeugestartet	TeleMaticManager.Station[1].Info.StationNeugestartet
Station neu verbunden	False	03.04.2014 17:17:41	TM.OPC_Station[1].Info.StationNeueverbindung	TeleMaticManager.Station[1].Info.StationNeueverbindung
Konfiguration	<?xml version="1.0" enocd...	03.04.2014 16:41:37	TM.OPC_Station[1].Info.Konfiguration	TeleMaticManager.Station[1].Info.Konfiguration
Konfiguration Fehler	False	03.04.2014 16:41:37	TM.OPC_Station[1].Info.KonfigurationFehler	TeleMaticManager.Station[1].Info.KonfigurationFehler
Konfiguration Version	4	03.04.2014 16:41:37	TM.OPC_Station[1].Info.KonfigurationVersion	TeleMaticManager.Station[1].Info.KonfigurationVersion
GPRS Verbindungsstatus	True	03.04.2014 15:08:21	TM.OPC_Station[1].Info.GprsVerbindungsstatus	TeleMaticManager.Station[1].Info.GprsVerbindungsstatus

System verbunden

Benutzer: Projektng

TeleMatic for the overview

TeleMatic Manager

TeleMatic Manager is the software at the central site for connecting the TeleMatic stations. TeleMatic Manager uses the very latest Microsoft technologies (.NET). This guarantees secure operation on current hardware with Microsoft operating systems.

Simple user interfaces enable access to the data on all connected TeleMatic stations. All process values can be viewed and enable diagnosis without previous parametrisation of the data in the SCADA system. An integrated connection monitoring provides a rapid overview of the communications status of the stations.

The data transfer to the SCADA system is performed via the OPC Classic and OPC UA industrial standard interfaces. TeleMatic Manager enables the simulation of all process values at the OPC interfaces. Fast engineering in the SCADA system is therefore possible even without a connected TeleMatic station.

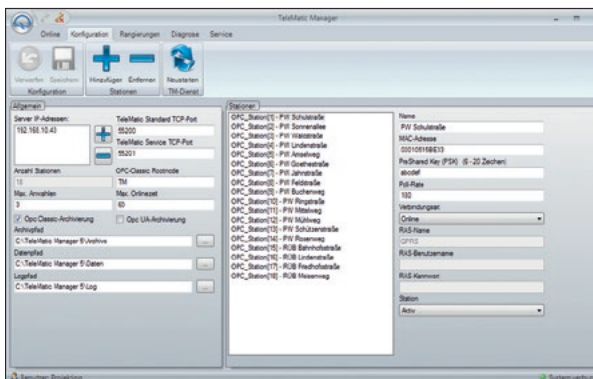

TeleMatic Manager – Configuration

Connected with the command centre via GPRS

Stadtwerke Winterberg public utilities company – Special structures all networked together

Due to the networking of the special structures in the sewage network with TeleMatic and the higher-level SCADA system SCADA V10, the Stadtwerke Winterberg public utilities company can observe the particularities of the network beyond the normal operation and can adjust operation appropriately. They have carried out decisive modernisations using this method that have enabled them to have better control.

Winterberg is one of the most well known places in Hochsauerland in Germany and it is, according to the inhabitants the "centre point of Hochsauerland", even if not geographically, then certainly as the centre of tourism in the land of a thousand mountains. Furthermore, Winterberg, located at 700 meters above sea level is the highest city in North Rhine-Westphalia. Around 14,000 inhabitants live here on the generous 15,000 hectares that they have to share with many tourists all through the year. The officially recognised climatic health resort receives around 1.2 million overnight stays and approximately 2 million day guests a

year. It is important to mention these numbers for the subsequent text, because the overall infrastructure of the city must be laid out accordingly. The Stadtwerke Winterberg public utilities company looks after a portion of this infrastructure. The company is organised as a public agency (AöR) since the beginning of 2007 and is responsible for water supply and sewage disposal for the city of Winterberg and the neighbouring scattered locations and residential areas. This also includes the operation of two sewage treatment plants.



The many plants, facilities and special structures of the water management infrastructure, which are operated by Stadtwerke Winterberg, are scattered just as widely as the locations and residential areas and they have been developed over the course of the years due to the increasing number of guests. The old control system was also rather outdated and was no longer suitable for the increasing number of tasks. A new and expandable solution was sought and found at HST in Meschede, Germany. The local proximity between Meschede, the HST company site and Winterberg was a crucial factor, as the inhabi-

tants of Winterberg were searching for a provider from the surrounding area. In particular, HST scored points in the first discussion in Winterberg with the system solution, with automations, remote monitoring and the process control system all coming from the same source. „The products and system solutions from HST impressed us“, said Henrik Weiß from Stadtwerke Winterberg. He was talking in particular about the solution for control and remote control technology that fitted the requirements profile precisely. „In addition, we were looking for a partner who was in a position to find the best solutions together with us and to ac-

company us in a competent manner“, said Weiß. The collaboration with HST began with the equipping of the special structures with long distance data transmission technology. In this way, the sewage network and the special structures were steadily brought up to the latest level of technology. The HST SCADA V10 process control system was set up and it was connected to 10 external stations via GPRS in the first step. As part of this process, a number of switchboards and automation states were also renewed. In the meantime, 23 special structures have been connected with the command centre via GPRS.



NiRA.web[®]

Precipitation data - At all times at every site

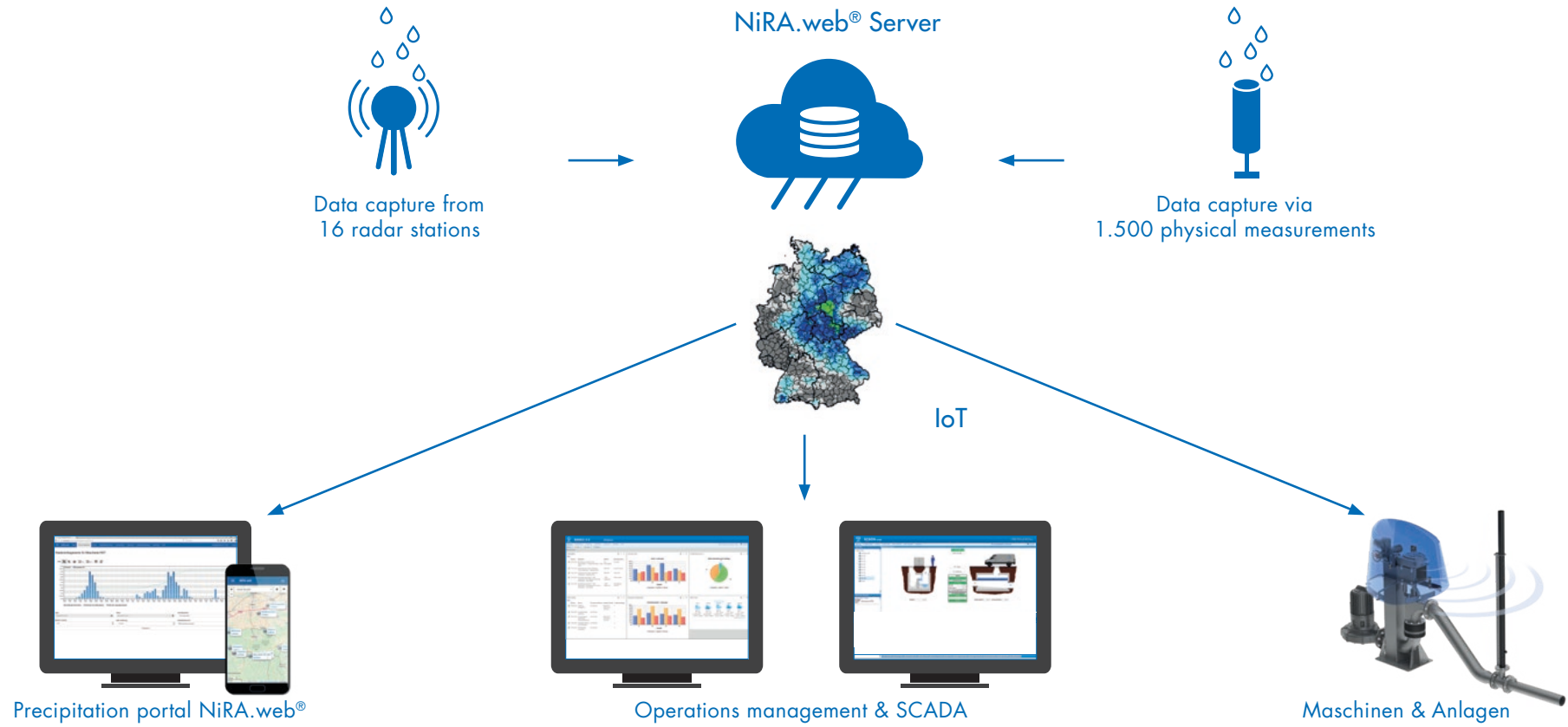

NiRA.web®

NiRA.web® is a Providing offer for precipitation data from HST and Kachelmann GmbH. The data provided are obtained from radar images and are checked via a dense measurement network of traditional pluviographs. Using this combination of radar and classic ground-level measurement networks, historic, current

and forecasted precipitation data can be provided for every location in Germany, Switzerland, Austria and Luxembourg. This innovative technology provides decisive benefits for water management and flood protection.

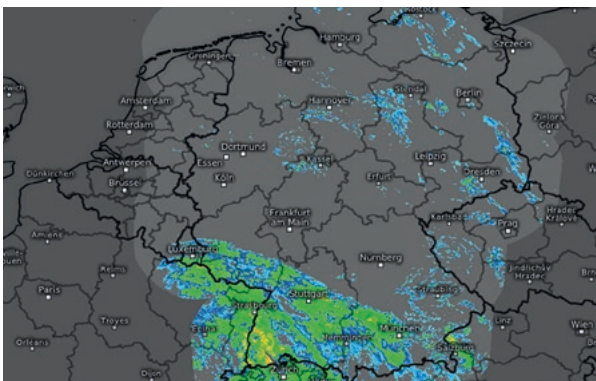

Rain radar and snow radar

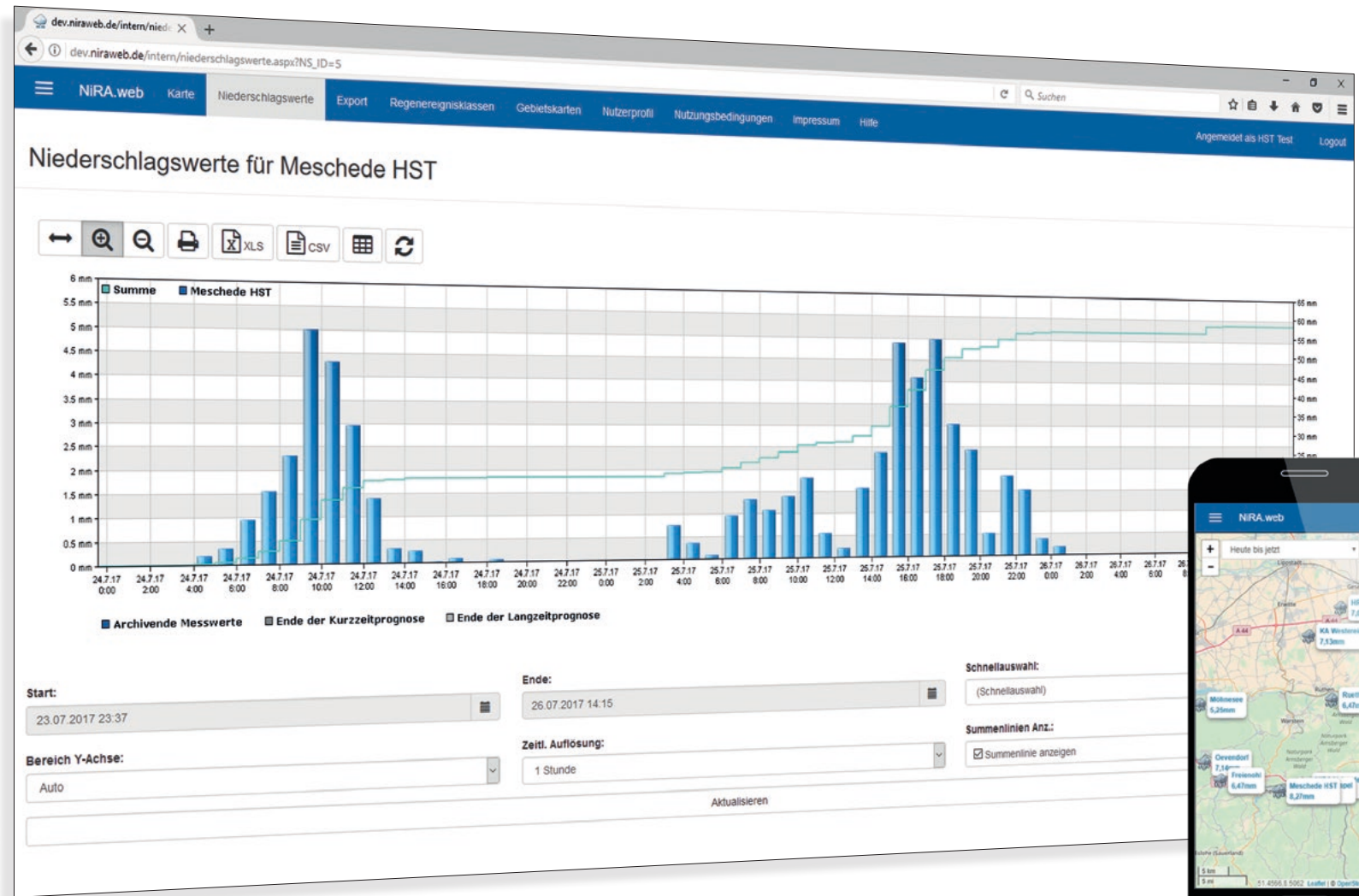

NiRA.web® Precipitation data - Precise and available online

PRODUCT DESCRIPTION

NiRA.web® provides a web-based information portal that makes precipitation data available at any time and place. The data that are available are prepared in a clear and comprehensible manner. A user-friendly evaluation displays the measurement series graphically. The precipitation series evaluated can be exported directly in Excel or CSV format, or they can be exported to third party systems. Additionally, the portal provides a cartographic representation of the development of precipitation in Germany with checked 6-hour precipitation totals. 16 radar stations and more than 1,500 ground level measuring stations gather precipitation data and provide weather forecasts for up to 72 hours via special weather modules.

Furthermore, NiRA.web® provides current information about precipitation and precipitation prognoses online directly to other software systems such as SCADA, web or KANiO® via an OPC UA interface. A particular advantage here is that the precipitation information can be transmitted online directly into the automation systems and can therefore be inserted into the automation as an additional process variable.

BENEFITS

- Nationwide precipitation measurement and prognoses for any locations in Germany, Austria, Luxembourg and Switzerland.
- Low investment, maintenance and servicing
- Easy exchange of data with other operators
- Spatial resolution 1 km²
- Temporal resolution to 5 minutes
- Convenient access via internet portal
- Simple data export
- Retrospective recalculation back to 2007 is possible
- Local forecast up to 72 hours in advance
- Alarm sending function via SMS and e-mail
- Online interface for precipitation information based on OPC UA
- Possible optimisation of processes
- Tank cleaning in city sewer systems and rain-water reservoirs using real information about precipitation and the cleaning requirements that are connected to this and corresponding automatically adjusted cleaning operations

HST YouTube channel:

www.youtube.com/user/HSTSystemtechnik

APPLICATIONS

- Flood protection
- Water supply
- Sewage network
- Sewage treatment plants
- Dams
- Agriculture
- Public utilities companies
- Hydroelectric power stations
- Wind power plants
- Transportation

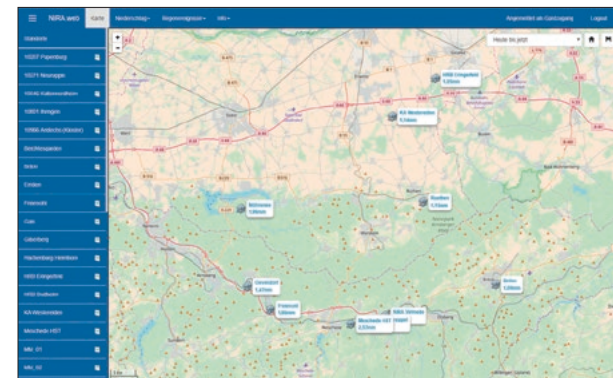

NiRA.web® Overview map



SensoMatic-EMA

Electronic quantities evaluation



SensoMatic-EMA

PRODUCT DESCRIPTION

The EMA system (E-values evaluation, elektronische Mengen-Auswertung) provides an optimal solution for the exact acquisition and evaluation of heavy rain amounts which are relieved via solid weir thresholds.

The EMA system consists of the following components:
EMA panel: Variable mechanical construction with E-scale optics for the recording, protection and precise adjustment of the sensors.

EMA sensors: High precision continuous measurement value capture and additional high benchmark point for calibration.

EMA controller: High resolution capture and archiving of measurement data in accordance with the delta event method with monitoring and calibration function.

EMA evaluation: User friendly data evaluation with graphical analysis tool and logging based on Microsoft Excel.

EMA measurement profile: Divided measurement profile to compare structural height difference and to improve precision.

HST YouTube channel:

www.youtube.com/user/HSTSystemtechnik

Web-configurator

ema.hst.de

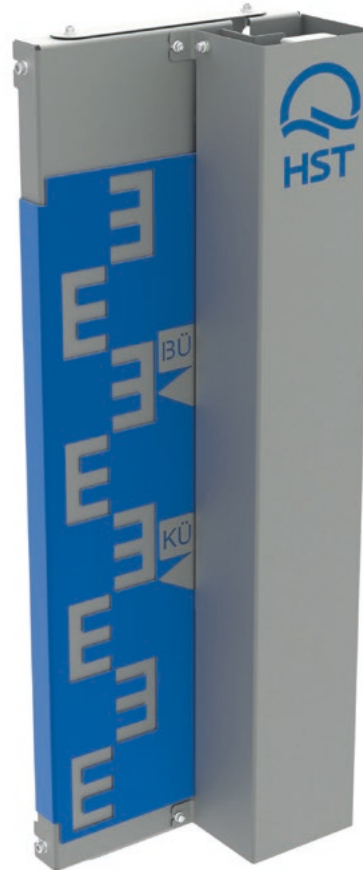



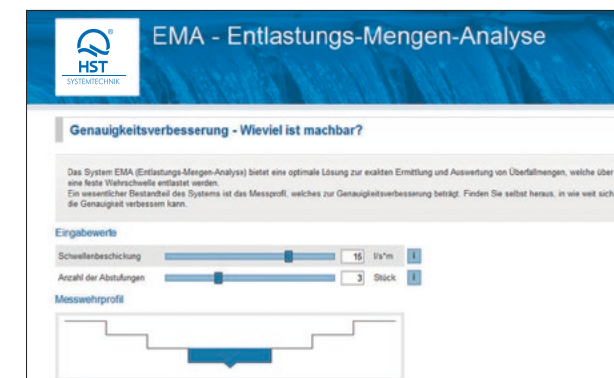

YOUR BENEFITS

- High precision measurement data capture
- Automatic calibration via reference signal
- Transparent data capture and comprehensible evaluation
- Exact acquisition of low heavy rain quantities via the measurement profile
- Maintenance friendly sensor protection and precise sensor adjustment
- Archiving in accordance with the HST delta event method
- Operator friendly evaluation and logging
- Reports are sent automatically in the PDF format
- Alarm sending function

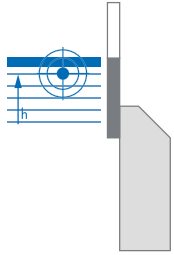
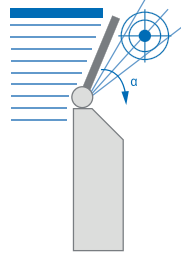
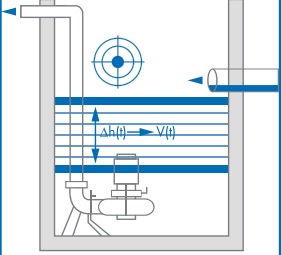
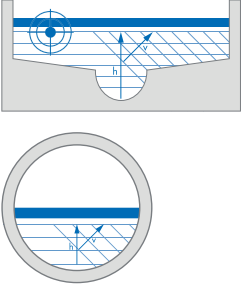

Online precision analysis: ema.hst.de

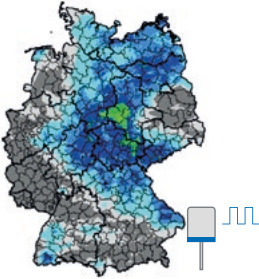
SensoMatic-EMA

MEASUREMENT PRINCIPLE	Filling level Pressure, ultrasound, radar	Angle, position, inclination, laser	Filling level, volumes, pressure, ultrasound, radar	Speed, filling level, magnetic-inductive, ultrasound, pressure	Speed, magnetic-inductive, ultrasound	Precipitation, radar, comparison with ground level measuring network
	EMA System [h] / [s]	EMA System [α]	EMA System [V]	EMA System [v/h]	EMA System [v]	NiRA.web [h_n]
APPLICATIONS						
	Fixed weir thresholds*	Movable gate, weir	Container	Profile	Profile	Precipitation forecast, data
	Gravity flow pipelines, partial filling				full filling	
INCREASE OF PRECISION	Segmentation or increase of measurement value resolution, e.g. backwater venturi channel, venturi flume, EMA measurement profile			Increase number of flow velocity sensors		Concentration of ground level network, increase resolution, radar
						



IntelliSystems

Intelligent process and machine control



IntelliSystems

Intelli-systems are available both as an extension to the HST machine and plant technology, and also as independent automation solutions for other brands. In contrast with traditional automation approaches, the Intelli-systems use sensor data and process information that provide information about the performance of the systems and plants. Machines are made more efficient and intelligent with Intelli-systems. Simply smart. Comparable with mobile operator devices, Intelli-systems provide the option to communicate with higher-level structures.

System	Application in the product	Brief description	Benefits
IntelliFlow	HydroMat-E	A system for the efficient self-monitoring and self-calibrating control and regulation of drainage	Permanently constant quality of regulation
	HydroMat-Q		
	HydroMat-P		
IntelliFlush	AWS-Flush Sluice	Flushing system for the effective and efficient automatic cleaning of sewers by the creation of flushing and transportation waves	Targeted condition-based flushing and transportation wave creation
IntelliGrid	AWS-Jet Cleaner	A system for the efficient and targeted cleaning of tanks by swivelling jet streams (Flowmaker) enables optical recording for the recognition of the level of contamination and needs-based cleaning (cleaning is only performed where it is required)	Automatically acting jet cleaner that is controlled in a targeted manner for the efficient and effective elimination of deposits
IntelliScreen	HSR-Screen	Improved containment / filtering effect thanks to the use of intelligent raking systems and filter systems in overflows from the sewer system into bodies of water	Efficient mass containment and increase of water quality due to additional filtering and discharge reliability
	VSR-Screen		
	LSR-Screen		
IntelliPump	All speed variable pumps > 20kW	Regulation for the optimised operation of pumps from determination/monitoring of the actual operating point	Continuous monitoring of the operating points, early recognition of wear/blockage and pressure loss
IntelliStream	Pure flux P2	A system for self-monitoring of the level of contamination detection to guarantee optimum cleaning results and efficient heat exchanger operation	Continuous monitoring of the operating points, early recognition of biological deposits and condition-based deposit elimination
	Sludge-Recuperator		

HST Systemtechnik GmbH & Co. KG **IntelliGrid**

Online 

Status

- Nullstellung
- Störung
- System OK
- Eco-Modus
- Super Eco-Modus

Betriebszeiten

Betriebsstunden	h
Schaltspiele	n

AWS Strahljet

Stellung

Pumpe



Becken

Niveau Becken

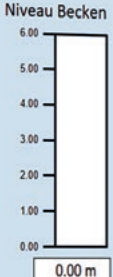

IntelliGrid

The AWS jet cleaner with IntelliGrid works particularly efficiently as additional information is incorporated into the automation of the AWS jet cleaner. This includes precipitation information in the form of current precipitation values and precipitation forecasts in the catchment area of the rainwater reservoir. Using these data, the smart machine knows when it last rained and whether a rainfall event will occur based on the precipitation forecast. In addition, the smart machine is trained by the IntelliGrid input grid about the input of deposits in the rainwater reservoir and it thus learns the optimum cleaning strategy.

Optionally, deposits can also be visually recorded via a camera and this provides additional information that leads to an efficient and optimal cleaning result.



Recording to deposits with HST TeleCam

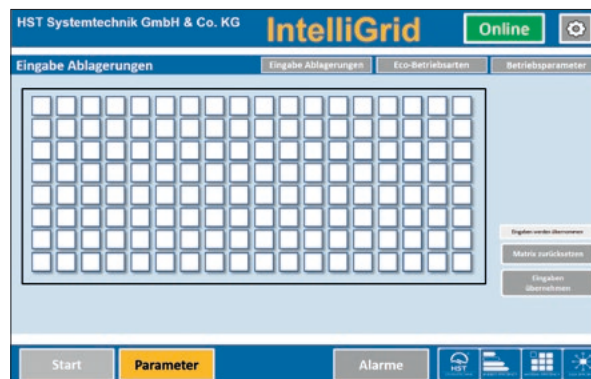

Input deposits

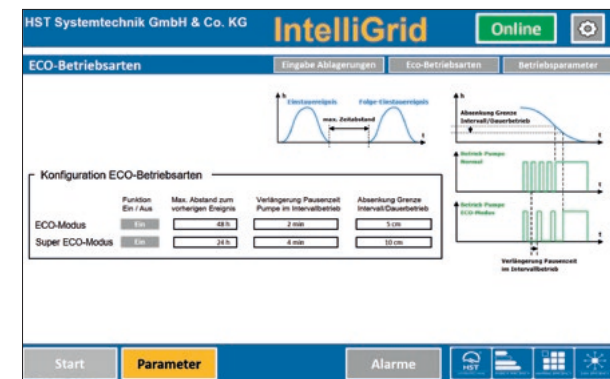

Settings ECO operation

HST Systemtechnik GmbH & Co. KG **IntelliScreen** Online

Messwerte

Wasserspiegel	2,30 m
Hydraulikdruck	0 bar
Öltemperatur	15 °C

Status

Automatik/Hand	Automatikbetrieb
Position	Endlage Rücklauf
Betriebszustand	Inaktiv / Aus
	Störung
	Überdruck
	Laufzeitüberschreitung
	Kurzlauf





Betriebszeiten

Betriebsstunden	h
Schaltspiele	n



max. WSP

Start **Parameter** **Alarme**

IntelliScreen

Thanks to its automation intelligence, an HSR screen with IntelliScreen provides improved mass containment and thus increases the water quality. Due to IntelliScreen, an optimum filter cake is constructed before the screen that is kept in an ideal condition by the dynamically controlled combing system.

The HSR screen with IntelliScreen is also provided with current precipitation data and precipitation forecasts online via IoT process variables and it is thus conditioned to the upcoming precipitation situations.



HSR screen with IntelliScreen in use

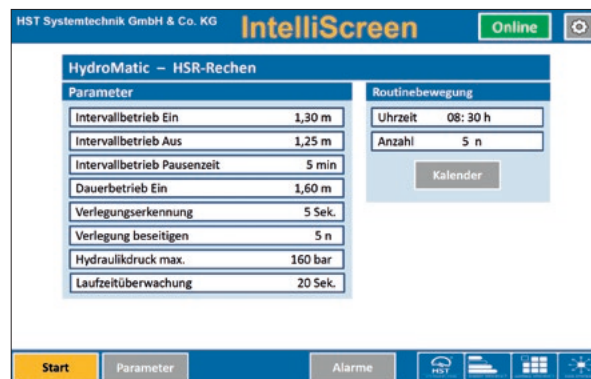

Setting IntelliScreen



HST Academy



HST Academy

Training courses with the system

We remain true to our motto „Networking that runs smoothly“ and we provide our customers with training courses for current HST IT products in the HST Academy. With the new range of training courses, HST is expanding the subject of support and service by an important component. We provide training for our customers in basic or advanced seminars for the KANiO®, SCADA V10, SCADA.web and TeleMatic products. In the event of specialised tasks, we are happy to help in providing training courses that are specially tailored to your individual requirements.



Modern and professional

In our modern training rooms, equipped with professional training equipment, we train our customers in technical one day or two day training courses in the areas of operation, administration, programming and project planning. The contents and scope of the training course are tailored for the prior knowledge, learning objectives and level of experience of the participants. The HST Academy also considers itself to be a place of communication - so all of the participants can profit from an interest exchange of experiences!



KANiO®

We provide further training for our customers in the KANiO® operations management system in basic and advanced seminars.

Basic seminar System Operators

- System operation
- Creation of object and occupation trees
- Creation of planning and templates
- Working with KANiO® mobile

Advanced seminar System Administrators

- Fundamental of SQL/databases
- User management
- Creation of filter queries
- Creating reports

More information at: Academy.hst.de



HST Academy

SCADA V10

We provide training in basic and advanced seminars for the SCADA V10 process control system so that operators and administrators are able to operate and administer their system safely and in the ideal manner.

Basic seminar System Operators

- System operation
- Connectivity
- Analysis and evaluation
- Alarm management

Advanced seminar System Administrators

- System administration
- Backup & restore
- User management
- Setting and adjusting process images
- Creating reports

SCADA.web

In the basic seminar training course for SCADA.web, we provide an introduction to all the important SCADA functions for the web portal and the SCADA app.

Basic seminar System Operators

- System operation
- Analysis and evaluation
- Handling the SCADA app

TeleMatic

We guide the operators and integrators in the safe and efficient handling of the TeleMatic remote control technology in the training course.

HST TeleMatic Standard

- Configuration and diagnosis
- System structure and interfaces

HST TeleMatic Manager

- Configuration and operation
- System structure and interfaces

SPS Programming in connection with HST TeleMatic

- Carrying out hardware configuration
- Getting to know and understanding typical application scenarios
- Creating example programs

More information at: Academy.hst.de



Services



Services from A-Z

With our comprehensive service package, we will support you as an operator from the idea, through project planning and up to the secure operation of your plants. A team of qualified and highly motivated experts and an optimum IT infrastructure are guaranteed to provide you with professional support for our products and systems.

We can guarantee you short response times, and everything is a part of the tailor-made service contracts. HST uses specialised management systems to ensure professional services. Our trouble ticket system displays the processing status of a reported error at all times and, at the same time, it makes the product quality transparent. The support hotline can be used 24 hours a day, 365 days a year.

IT-Support KANiO®, SCADA and TeleMatic

- Support hotline
- 24 hour/365 day support hotline
- Troubleshooting with response times
- Provision of updates
- Installation of updates
- TeleMatic spare part availability
- Data backups
- System inspections and optimisation
- Advice on IT security
- Support for internal and external IT security audits

11.05.2018

Provision
KANiO 4.2

01.04.2018

Provision
SCADA APP V1.0

01.06.2017

Provision
SCADA V10.3

01.04.2017

Provision
SCADA.web 2.8

HST IT Product roadmap

HST software development

From a requirement to a practice-oriented product

In the course of the release cycles for our software products, the user takes on a significant role and helps the development team to develop a user-oriented product. Product requirements are incorporated into the development process via a continuous dialogue between the project engineers and the users. All requirements and customer requests for every product are recorded in our enterprise wiki system and are combined with the ideas of the product manager and product developers. After a technical assessment, all requirements are ordered, prioritised and are then recorded in a product specification sheet. The product development itself is subject to an agile development process so that it is possible to react quickly and flexibly to new requirements and market trends.

With this continuous development process, all products are developed with a practical orientation and are offered to our customers in the form of an annual product update or are available free of charge as part of an existing service contract. In this way, it is ensured that you are always kept up to date, that current operating systems are supported and that IT security is ensured.



Product roadmap IT & automation



Thinking together in terms of solutions

Partner for all solutions

With our solution partners, we ensure that our services are looked after by experts in all industry sectors and in all regions.

They are listed, trained and certified partners who possess the technical knowledge for project planning with our products. These solution partners are responsible for the project planning for providing the end customer with an overall solution using HST products and systems.

Currently, the network consists of around 15 solution partners all over Germany. These partners take on the project management and marketing on site and ensure fast and qualified after sales service after commissioning.

The requirements placed on solution partners who work together with HST are high.

The following criteria apply:

- Experience in consulting for system solutions
- Industry sector specific expertise in the
- HST target markets
- Proof of corresponding references
- Experience in project planning for process control systems or operations management systems, or in the area of machine and plant engineering
- Being active in the sector for a minimum of five years

In return, HST supports the solution partners in many respects:

- Support for project planning
- Free of charge support hotline and
- direct contact person
- Direct exchange with the software developers
- Comprehensive documentation
- Attractive purchasing terms
- Free of charge project planning licence
- Comprehensive service package
- Sales and marketing support
- White Label web portal for remote monitoring and remote control

This only has benefits for the customers They receive all consulting services for the HST products direct from the solution partner. Fast support and service from this partner is also ensured. The service contracts are thus concluded between the end customer and the solution partner. In parallel, there is also a service contract between HST and the solution partner. Invoicing with the customer also takes place directly via the solution partner on location.



Imprint**Editor:**

HST Systemtechnik GmbH & Co. KG
Heinrichthaler Straße 8
59872 Meschede
GERMANY

Telephon +49 291 9929 0

Telefax +49 291 7691

E-Mail info@hst.de

Internet: www.hst.de

Content responsibility according to § 6 MDSiV

Komplementärin:

HST Systemtechnik-Verwaltungs-GmbH
AG Arnsberg HRB 3416

GF Dipl.-Ing. Richard Ernst

GF Dipl.-Ing. Martin Frigger

GF Dipl.-Ing. MBA Werner Bücken

GF Dipl.-Ing. Thomas Grünig

Images:

S. 60 und S. 93

Illustration lower right with kind permission of Siemens AG

Design:

smile. Visuelle Kommunikation, Essen/Germany

Unterberg & Wulfange GbR

www.designsmile.de

Texts:

Marc Raschke

www.raschke-partners.de

Print:

Agentur Kleffner, Meschede

kleffner@meschede.net



All rights reserved.

© 2018 HST Systemtechnik GmbH & Co. KG

The products and projects presented are services from HST Systemtechnik GmbH & Co. KG and the affiliated companies, for example EST Elektro-Systemtechnik GmbH, Pegasys – Gesellschaft für Softwareentwicklung mbH, HST Hydrosystémy s.r.o. (CZ), HST Holding GmbH, HST Beteiligungs GmbH. All of the information has been determined with due diligence. We shall accept no liability for data provided by third parties or provided by mistake, or for any printing errors. We also reserve the right to make changes as a result of advances made! Additional information: www.hst.de

Stadt Künzelsau Gemeinde Lahstedt Verbandsgemeinde Lambrecht Stadt Landau i.d. Pfalz Städtische Werke Landsberg Stadt Landshut Stadtwerke Langen Gemeinde Langerringen
Stadt Laupheim Wasserzweckverband Lechfeld Gemeinde Legden Stadt Leichlingen Gemeinde Leidersbach Stadtwerke Leipzig Gemeinde Leisnig Stadt Lennestadt Stadt
Leverkusen Mesto Liberec (CZ) Gemeinde Lienen Linde-KCA-Dresden GmbH Anlagenbau Linz GmbH Stadt Linz (A) Lippeverband Stadtwerke Lübbecke Hansestadt Lübeck Stadt
Lüdenscheid Stadtwerke Lünen Stadtwerke Ludwigsburg-Kornwestheim GmbH Stadt Ludwigshafen Ljutomer d.o.o.(SI) Cite Luxemburg (L) Laute Pumpwerksbau Logport Duisburg
GmbH Mesto Ljubljana (SI) Mählmann-Gemüsebau GmbH & Co. KG Mesto Malzenice (SK) City of Manama (BH) Markt Manching Stadt Mannheim Stadt Marburg Max Bögl
Bauservice GmbH und Co. KG Mayer GmbH Biogasanlage Marsberg Verbandsgemeinde Maxdorf MEAB Märkische Entsorgungsanlagen-Betriebsgesellschaft Stadt Medebach
Stadtwerke Meinerzhagen MeiTec GmbH Stadt Meschede Kläranlage Mittleres Glemstal Wasserversorgung Memmelsdorf Stadt Menden Stadt Meppen Mercedes Benz AG
Mettenmeier GmbH Stadt Metzingen Abwasserverband Mittlere Mümling Stadt Minden Ministry of Works, Bahrain (BH) MK GmbH Mesto Mislinja (SI) Stadt Montabaur Stadt
Mönchengladbach Stadt Moers Stadtwerke Mönchengladbach GmbH Stadtwerke Mosbach Abwasserzweckverband Muldental Matthes Messtechnik GmbH Stadt Mühlheim
an der Ruhr Stadt München MRM Anlagenbau GmbH Stadtwerke Münster Nabaltec GmbH Mesto Nachod (CZ) Stadtwerke Naumburg Markt Nesselwang Stadt Netphen
Stadt Neuburg an der Donau Stadt Neukirchen Stadt Neukirchen-Vluyn Gemeinde Neunkirchen Stadt Neulengbach (A) Gemeinde Neu Wulmstorf Stadt Neusäß Stadt Neuss
Gemeinde Niederkrüchten Gemeinde Niefern-Öschelbronn Niersverband Stadtwerke Niesky Gemeinde Niittendorf Nizhnekamsk (RU) Nolte Bauunternehmung GmbH & Co. KG
Landratsamt Nordhausen Stadt Nordhorn Stadt Nossen Stadt Nürnberg Gemeinde Oberschleißheim Abwasserverband Oberes Günztal Abwasserverband Oberes Pfinz- und
Arnbachtal Stadt Oberhausen Stadtwerke Ochtrup Gemeinde Otterdingen Grad Ogulin (HR) Olbring & Partner GmbH Große Kreisstadt Öhringen OÖVV Oldenburgisch
Ostfriesischer Wasserverband Stadt Olpe Stadtwerke Olsberg Stadtwerke Osnabrück OST Bau GmbH Opel Eisenach GmbH Over GmbH ZV Wasser und Abwasser Orla
OKOJE CONSULTING D.O.O. (SI) ZVO Zweckverband Ostholstein Stadt Paderborn Oras Parau (RO) Passavant-Geiger GmbH Passavant-Roediger Controls GmbH Passavant-
Watec GmbH Gemeinde Pfedelbach Stadt Pforzheim Stadt Philippsburg Stadt Pirmasens Stadtwerke Plettenberg Plate Stahl Umformtechnik GmbH PMT GmbH PORR Deutschland
GmbH Porsche AG Stadtwerke Radevormwald Stadt Rastatt Stadt Ratingen Raab Baugesellschaft mbH & Co. KG Elektrizitätswerke Reutte GmbH (A) Rick GmbH & Co. KG
Stadt Recklinghausen Stadt Regensburg Gemeinde Reinhardshagen REMONDIS AG & Co. KG Stadt Remscheid Stadt Rheinfelden Gemeinde Röttenbach Hansestadt Rostock
Stadt Rothenburg o. d. Tauber Molkerei Rücker GmbH Ruhrverband Gemeinde Ruppichterath Stadtwerke Rütten RWE Power AG RWE Dea AG Zweckverband Wasserversorgung
und Abwasserbeseitigung Saalfeld Stadt Saarbrücken Stadt Saarwellingen Stadtwerke Salzkotten Gemeinde Schalksmühle Scheele GmbH S.C. GRUP ROMET S.A. (RO) Schönhoff
GmbH & Co. KG Stadtwerke Schlüchtern Stadt Schmallingen Stadt Schöneck Gemeinde Schöppingen Stadt Schorndorf Stadtwerke Schramberg WVE Wasserversorgungs-
und entsorgungsgesellschaft Schriesheim mbH Stadt Schwabach Abwasserverband Schwabachtal Markt Schwaben Stadt Schwäbisch Gmünd Stadtwerke Schwalmstadt Stadt
Schwandorf Stadt Schweinfurt Stadt Schwelm Stadtwerke Schwerte GmbH Verbandsgemeindewerke Selters Stadt Sendenhorst Sidero (L) Stadt Siegen Siepman-Werke
GmbH & Co. KG Gemeinde Simmerath Gemeinde Simmersfeld Entsorgungsbetrieb Simmering GmbH Cite Sivom de la vallee de munster (F) Oras Sinandrei (RO) Sindelfingen
Stadtwerke GmbH Stadtwerke Sinzig Stadt Soest Stadt Solingen Sotravac Ltee, Mauritius Spaans Babcock bv Stadt Spaichingen Spangler GmbH Stadtwerke St. Ingbert
Stadt St. Leon-Rot Gemeinde St. Märgen Stadtwerke Stade Stadt Stadtlohn Abwasserverband Steinachtal Stadt Steinfurt Stadtwerke Steinhagen Steirische Gas-Wärme GmbH
(A) Gemeinde Stewede Gemeinde Stephanskirchen Stewering GmbH & Co. KG Stoll Prozessleittechnik GmbH Stadt Stuttgart Strabag AG Hansestadt Stralsund Struktur-
und Genehmigungsdirektion Süd Stulz-Planaqua GmbH Flughafen Stuttgart GmbH Süwag Wasser GmbH Suisselectra Ingenieurunternehmung AG Gemeinde Sulzbach-Laufen Stadt
Sulzbachtal Stadt Sundern S-Pro Automation GmbH SüdWasser GmbH Ciudad Tarragona (E) Stadt Telgte ThyssenKrupp AG Oras Timisoara (RO) Stadt Tittisee-Neustadt Stadt
Trier Stadtwerke Troisdorf GmbH Mesto Trutnov (CZ) Regierungspräsidium Tübingen Stadt Tuttlingen UAB Samsonas Kaunas (LT) Gemeinde Uchte SWU Stadtwerke Ulm/Neu-Ulm
GmbH Stadt Unna Abwasserverband Untere Brenz Abwasserzweckverband Untere Zschopau Stadtwerke Unterschleißheim Stadt Vaihingen Ciudad Valencia (E) Stadt Vechta
Mesto Velenje (SI) Stadtwerke Vellmar Gemeinde Villmar ZWAV Zweckverband Wasser und Abwasser Vogtland VW AG Gemeinde Wadersloh Stadtwerke Waiblingen GmbH
Abfallwirtschaft des Landkreises Waldeck-Frankenberg Stadt Walldorf Stadtentwässerung Waltrop Stadt Warburg Stadtwerke Warendorf Stadt Warstein WARSTEINER Brauerei
Haus Cramer KG Gemeinde Wartenberg W.A.S. Wasser- Abwasser Systemtechnik GmbH Water HST Systemtechnik S. L. (E) Stadt Weil der Stadt Abwasserbeseitigungsgesellschaft
Weißenberg GmbH Stadtwerke Werdohl GmbH Stadt Wermelskirchen Stadt Wernberg-Köblitz Werre-Wasserverband Weser-Ems-Erfrischungsgetränke GmbH Stadt Wesseling
Stadt Wetter/Ruhr Stadt Wien (A) Stadt Willich Gemeinde Willingen Gemeinde Wilnsdorf Gemeinde Windeck Stadt Winterberg Stadt Wipperfürth Stadt Wiesbaden Stadtwerke
Wiitten GmbH WOL Wasserverband Obere Lippe Stadt Würzburg Wuppertaler Stadtwerke AG Grad Zagreb (HR) ZGOS d.o.o (HR) Verbandsgemeinde-Werke Zweibrücken-Land

next level technology

HST Systemtechnik GmbH & Co. KG
Heinrichthaler Straße 8
59872 Meschede
GERMANY

Telefon +49 291 9929 0
Telefax +49 291 7691

info@hst.de
www.hst.de